



POOLS 2024



■ índice

■ index

■ sommaire

■ indice

03



- INTRODUCCIÓN
- INTRODUCTION
- INTRODUCTION
- INTRODUZIONE

10



- PISCINAS DE MADERA
- WOODEN POOLS
- PISCINES BOIS
- PISCINA IN LEGNO

36



- PISCINAS DE COMPOSITE
- COMPOSITE POOLS
- PISCINES COMPOSITE
- PISCINA IN COMPOSITE

44



- PISCINAS DE ACERO
- STEEL WALL POOLS
- PISCINES PAROI ACIER
- PISCINA IN ACCIAIO

76

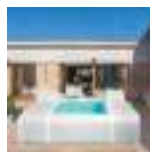

- PISCINA MARIPOSA
- MARIPOSA POOL
- PISCINA MARIPOSA
- PISCINA MARIPOSA

78



- PISCINAS ENTERRADAS
- IN-GROUND POOLS
- PISCINES ENTERRÉES
- PISCINE INTERRATA

86



- COMPLEMENTOS
- COMPLEMENTS
- COMPLEMENTS
- COMPLEMENTI

150

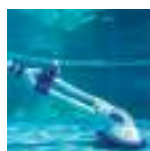

- MATERIAL DE LIMPIEZA
- CLEANING MATERIAL
- MATÉRIEL DE NETTOYAGE
- MATERIALE DI PULIZIA

184



- PRODUCTO QUÍMICO
- CHEMICALS
- PRODUITS D'ENTRETIEN
- CHIMICI

■ Novedades ■ New products ■ Nouveautés ■ Nuovo



WA000082 IQBRIDGE ZB

- Control remoto por Wi-Fi para enchufes inteligentes
- Remote control over Wi-Fi for Smart Plugs
- Contrôle à distance par Wi-Fi des prises intelligentes
- Controllo remoto tramite Wi-Fi per le spine intelligenti

76671 76673 SMART PLUGS

- Enchufe inteligente estanco que ofrecen control por app plug & play para el equipo de piscina
- Watertight smart plug delivering plug & play app control for the pool equipment
- Des prises intelligentes étanches offrant un contrôle d'application plug & play pour l'équipement de piscine
- Spina intelligente a tenuta stagna che offre un controllo plug & play tramite app per le attrezzature della piscina.



VSG75

- Bomba de velocidad variable
- Variable speed pump
- Pompe à vitesse variable
- Pompa a velocità variabile



76111

- Hipoclorito cálcico en sticks
- Calcium hypochlorite in sticks
- Hypochlorite de calcium en bâtonnets
- Ipoclorito di calcio in bastoncini



GSS25 GSS50 | DREAM SALT

- Clorador salino para piscinas elevadas
- Saltwater chlorinator for above ground pools
- Electrolyse au sel pour piscine hors sol
- Elettrolisi salina per piscina fuori terra



RBR120 | WETRUNNER XPRT

- Robot a batería
- Battery robot
- Robot à batterie
- Robot a batteria



FULL INVERTER HEAT PUMPS

- Gama completa de bombas de calor inverter con conectividad
- Full inverter heat pumps range with connectivity
- Gamme complète de pompes à chaleur inverter avec connectivité
- Gamma completa di pompe di calore inverter con connettività



76112 | 76113

- Estabilizador de cloro
- Chlorine stabiliser
- Stabilisateur de chlore
- Stabilizzatore di cloro



NEW
2024

FAQC40

- Filtro Aqualoon
- Aqualoon filter
- Système de filtration Aqualoon
- Sistema di filtrazione Aqualoon



CSPAN | HEALTH VAC PLUS

- Limpiafondos eléctrico
- Electric cleaner
- Nettoyeur de fond électriques
- Pulitore elettrico



LE75

- Limpiafondos a batería
- Battery cleaner
- Nettoyeur de batterie
- Pulitore per batterie



76114

- Stop metal
- Stop metal
- Arrêt métal
- Stop al metallo



■ PRESENTACIÓN DE LA EMPRESA

Gre es una empresa con más de 50 años de experiencia en la fabricación de piscinas elevadas.

Como empresa pionera en el sector, somos especialistas y líderes a nivel europeo.

Nuestra apuesta clara por la calidad y seguridad de todos nuestros productos, nos convierte en la referencia fundamental del mercado.

Nuestra empresa ofrece una amplia gama de productos: piscinas elevadas de diferentes formatos y acabados, una completa línea de accesorios para su equipamiento y mantenimiento y una serie de productos químicos diseñados específicamente para el agua de la piscina.

Con el ánimo de satisfacer siempre al cliente, Gre ha diseñado una estrategia de servicios, cuyo objetivo es ofrecer una solución integral. Nuestra amplia red de Servicios Técnicos, así como nuestros Departamentos de Atención al Cliente, son la mejor prueba de ello. Estos servicios nos permiten asesorarle sobre la opción de piscina y equipamiento más adecuados a sus necesidades.

■ PRÉSENTATION DE L'ENTREPRISE

Gre est une société spécialisée dans la fabrication de piscines hors-sol.

Pionnière dans le secteur, notre entreprise est SPÉCIALISTE et LEADER en EUROPE.

Notre pari sur la QUALITÉ et la SÉCURITÉ de tous nos produits nous permet d'être la principale RÉFÉRENCE du marché.

Notre entreprise offre une LARGE GAMME de produits, allant des piscines hors-sol aux tailles et finitions diverses et variées, jusqu'à un éventail complet des accessoires nécessaires à l'équipement et à l'entretien, et une gamme de produits chimiques conçus spécifiquement pour l'eau de la piscine.

Toujours dans le but de satisfaire les clients, Gre a conçu une stratégie de SERVICES dont l'objectif est d'offrir une réponse et une solution complètes grâce à son large réseau de Services Techniques et à son Service client. Ces services nous permettent de vous conseiller tant sur le choix de votre piscine que de l'équipement le plus approprié à vos besoins.

■ COMPANY PRESENTATION

Gre is a company with more than 50 years experience in manufacturing above-ground pools.

As a pioneer company on its field, we are SPECIALISTS and LEADERS within the European market.

We are considered to be a fundamental market REFERENCE as a result of our clear wager on QUALITY and SECURITY of all our products.

Our company offers a WIDE RANGE of products which includes: different sizes and finishes aboveground pools, a complete range of accessories for their equipment and maintenance and a number of swimming pool chemicals designed specifically for the pool water.

Bearing in mind our customers satisfaction, Gre has designed an important SERVICES strategy whose aim is to offer an integral solution. Our wide network of Technical Services and our Customer Service Departments are the best proof of that. These services help us to identify our customers needs and to advice them on the best pool and equipment according to those needs.

■ PRESENTAZIONE DELL'AZIENDA

La Gre è un'azienda con oltre 50 anni di esperienza nella produzione di piscine smontabili su terra.

Come impresa pioniera nel settore, siamo SPECIALISTI e LEADER a livello EUROPEO.

La nostra chiara scommessa sulla QUALITÀ e sulla SICUREZZA di tutti i nostri prodotti, fa di noi il RIFERIMENTO fondamentale del mercato.

La nostra società offre una VASTA GAMMA di prodotti: piscine elevate di diversi formati e rifiniture, una completa linea di accessori per l'attrezzatura e la manutenzione e una serie di prodotti chimici pensati specificamente per l'acqua della piscina.

Sempre con l'intenzione di soddisfare il cliente, la Gre ha progettato una strategia di SERVIZI il cui scopo è quello di offrire una soluzione integrale. La nostra vasta rete di Servizi Tecnici, così come i nostri Reparti di Servizio al Cliente, ne sono la miglior prova. Tali servizi ci consentono di dare consulenza sulla scelta della piscina e dell'equipaggiamento più idoneo alle vostre necessità.

■ Consejos para ahorrar agua en tu piscina ■ Tips for saving water in your pool ■ Recommandations pour économiser l'eau dans votre piscine ■ Consigli per risparmiare acqua in piscina



■ HAZTE CON UNA CUBIERTA ISOTÉRMICA

El uso de una cubierta durante la temporada alta (4 meses) supone un 50% menos de evaporación de agua.

■ OFFREZ-VOUS UNE COUVERTURE D'ÉTÉ

L'utilisation d'une couverture isothermique pendant la haute saison (4 mois) permet de réduire de 50 % l'évaporation de l'eau.

■ GET YOURSELF A SUMMER COVER

Using an isothermic cover during high peak season (4 months) leads to a 50% less of water evaporation.

■ PROCURATEVI UNA COPERTINA ESTIVA

L'utilizzo di una copertura isothermica durante l'alta stagione (4 mesi) comporta una riduzione del 50% dell'evaporazione dell'acqua.



■ UTILIZA UNA CUBIERTA DE INVIERNO

El uso de una cubierta durante el resto del año supone un 95% menos de evaporación de agua.

■ UTILISER UNE HOUSSE D'HIVERNAGE

L'utilisation d'une couverture hivernale pendant le reste de l'année permet de réduire de 95 % l'évaporation de l'eau.

■ USE A WINTER COVER

Using a winter cover during the rest of the year leads to a 95% less of water evaporation.

■ USARE UNA COPERTURA INVERNALE

L'utilizzo di una copertura invernale durante il resto dell'anno comporta una riduzione del 95% dell'evaporazione dell'acqua.



■ AQUALOON, UN FILTRO ECOLÓGICO

Las bolas de filtrado necesitan una menor frecuencia de lavado, alargando así su vida útil y permitiendo el ahorro de agua.

■ AQUALOON, LE FILTRE ÉCOLOGIQUE

Le sfere filtranti devono essere lavate con minore frequenza. In questo modo, prolungano la loro vita utile e consentono di risparmiare acqua.

■ AQUALOON, ECOLOGICAL FILTER

Filter balls need to be washed with less frequency. Like this, they extend their useful life while allowing water saving.

■ AQUALOON, IL FILTRO ECOLOGICO

Les boules filtrantes doivent être lavées moins souvent. Elles prolongent ainsi leur durée de vie tout en permettant d'économiser l'eau.



■ AHORRA AGUA CON UN FILTRO DE CARTUCHO

Comparado con un filtro de arena, el filtro de cartucho reduce el consumo de agua hasta un 90% en cada lavado de cartucho.

■ ÉCONOMISER L'EAU AVEC UN FILTRE À CARTOUCHE

Si on le compare à un filtre à sable, le filtre à cartouche peut réduire la consommation d'eau jusqu'à 90 % à chaque lavage de cartouche.

■ SAVE WATER WITH A CARTRIDGE FILTER

If we compare it with a sand filter, cartridge filter can reduce the consumption of water up to a 90% on each cleaning of the cartridge.

■ RISPARMIARE ACQUA CON IL FILTRO A CARTUCCIA

Se lo confrontiamo con un filtro a sabbia, il filtro a cartuccia può ridurre il consumo di acqua fino al 90% per ogni lavaggio della cartuccia.



■ LA IMPORTANCIA DE UN TRATAMIENTO CORRECTO

Minimizarás la renovación de agua de la piscina haciendo un tratamiento adecuado a partir de la electrolisis salina o productos químicos.

■ L'IMPORTANCE D'UN TRAITEMENT CORRECT

Vous minimiserez le renouvellement de l'eau de la piscine en suivant un traitement adéquat par électrolyse du sel ou par des produits chimiques.

■ THE IMPORTANCE OF A CORRECT TREATMENT

You'll minimize the pool water renewal by following a proper treatment with salt electrolysis or chemical products.

■ L'IMPORTANZA DI UN TRATTAMENTO CORRETTO

Ridurrete al minimo il rinnovo dell'acqua della piscina seguendo un trattamento adeguato con elettrolisi del sale o prodotti chimici.



■ NO TE OLVIDES DE TU PISCINA EN INVIERNO

Un tratamiento adecuado con producto químico de invierno, facilitará la puesta en marcha de la piscina evitando vaciarla.

■ N'OUBLIEZ PAS VOTRE PISCINE PENDANT L'HIVER

Un traitement adéquat avec des produits chimiques d'hivernage vous aidera à mettre en service la piscine et vous évitera de la vider.

■ DON'T FORGET ABOUT YOUR POOL DURING THE WINTER

An adequate treatment with winterizing chemicals will help you with the start-up of the pool and you will avoid emptying it.

■ NON DIMENTICATEVI DELLA VOSTRA PISCINA DURANTE L'INVERNO

Un trattamento adeguato con prodotti chimici svernanti vi aiuterà nella messa in funzione della piscina e vi eviterà di svuotarla.



■ DETECTA FUGAS Y AVERÍAS

Asegúrate de que el sistema de filtración y las válvulas están correctamente instalados. En caso de que detectes una fuga en el liner, nuestros kits reparadores podrán ayudarte a solucionarlo.

■ DÉTECTER LES FUITES ET LES DÉFAUTS À TEMPS

Assurez-vous que votre système de filtration ainsi que les vannes sont correctement installés. Si vous constatez une fuite sur le liner, nos kits de réparation vous aideront à la résoudre.

■ DETECT LEAKS AND FAULTS ON TIME

Make sure that your filtration system as well as valves are correctly installed. In case you find out a leak on the liner, our reparation kits will help you to solve it.

■ INDIVIDUARE IN TEMPO PERDITE E GUASTI

Assicuratevi che il sistema di filtrazione e le valvole siano installati correttamente. Nel caso in cui si riscontri una perdita sul liner, i nostri kit di riparazione vi aiuteranno a risolverla.



■ INSTALA UN DEPÓSITO DE AGUA

Un tanque de recuperación para el agua te permitirá compensar las pérdidas por el efecto de evaporación.

■ INSTALLER UN RÉSERVOIR D'EAU

Un réservoir de récupération d'eau vous permettra de compenser la perte d'eau due à l'évaporation.

■ INSTALL A WATER DEPOSIT

A water recovery tank will allow you to compensate the loss of water due to evaporation effect.

■ INSTALLARE UN DEPOSITO D'ACQUA

Un serbatoio di recupero dell'acqua consente di compensare la perdita di acqua dovuta all'effetto di evaporazione.

■ Consejos para ahorrar energía en tu piscina ■ Tips for saving energy in your pool ■ Recommandations pour économiser l'énergie dans votre piscine ■ Consigli per risparmiare energia in piscina



■ APROVECHA AL MÁXIMO LA ENERGÍA SOLAR

Los calentadores solares calentarán el agua de tu piscina de manera eficaz y sin consumir energía. Las duchas solares aprovechan la energía del sol para calentar un acumulador de agua que te permite disponer de agua caliente durante todo el día sin necesidad de utilizar energía.

■ TIRER LE MEILLEUR PARTI DE L'ÉNERGIE SOLAIRE

Les chauffe-eau solaires chauffent l'eau de votre piscine de manière efficace et sans consommer d'énergie. Les douches solaires utilisent l'énergie solaire pour chauffer un réservoir d'eau qui vous permet d'avoir de l'eau chaude toute la journée sans consommer d'énergie.

■ MAKE THE MOST OF SOLAR ENERGY

Solar water heaters will heat your pool water efficiently and without consuming energy. Solar showers use the sun's energy to heat a water storage tank that allows you to have hot water all day long without using energy.

■ SFRUTTARE AL MEGLIO L'ENERGIA SOLARE

Gli scaldacqua solari riscaldano l'acqua della piscina in modo efficiente e senza consumare energia. Le docce solari sfruttano l'energia del sole per riscaldare un serbatoio di accumulo che consente di avere acqua calda tutto il giorno senza consumare energia.



■ SISTEMAS DE FILTRACIÓN CON EL CONSUMO MAS BAJO DEL MERCADO

Garantiza el ahorro en tu piscina con los sistemas de filtración de Gre. Tienen el consumo más bajo del mercado.

■ SYSTÈMES DE FILTRATION AVEC LA CONSOMMATION LA PLUS BASSE DU MARCHÉ

Garantisiez des économies dans votre piscine avec les systèmes de filtration Gre. Ils ont la consommation la plus faible du marché.

■ FILTRATION SYSTEMS WITH THE LOWEST CONSUMPTION ON THE MARKET

Guarantee savings in your pool with Gre filtration systems. They have the lowest consumption on the market.

■ SISTEMI DI FILTRAZIONE CON I CONSUMI PIÙ BASSI DEL MERCATO

Garantite il risparmio nella vostra piscina con i sistemi di filtrazione Gre. Hanno il consumo più basso del mercato.



■ LAS BOMBAS DE CALOR, EL MÉTODO MAS EFICIENTE PARA CALENTAR LA PISCINA

Una gran solución para la climatización de piscinas, alarga la temporada de baño al menor coste energético.

■ LES POMPES À CHALEUR, LE MOYEN LE PLUS EFFICACE DE CHAUFFER VOTRE PISCINE

Une solution idéale pour le chauffage des piscines, qui permet de prolonger la saison de baignade à moindre coût énergétique.

■ HEAT PUMPS, THE MOST EFFICIENT WAY TO HEAT YOUR POOL

A great solution for pool heating, extending the swimming season at the lowest energy cost.

■ POMPE DI CALORE, IL MODO PIÙ EFFICIENTE PER RISCALDARE LA PISCINA

Un'ottima soluzione per il riscaldamento della piscina, che consente di prolungare la stagione balneare al minor costo energetico.



■ LED PARA PISCINAS, UNA ILUMINACIÓN DE BAJO COSTE

Gracias a nuestros sistemas de iluminación, podrá disfrutar de su piscina en cualquier momento. En Gre contamos con proyectores con los que podemos ahorrar hasta un 90% de consumo frente a los halógenos.

■ LED POUR PISCINES, ÉCLAIRAGE ÉCONOMIQUE

Grâce à nos systèmes d'éclairage, vous pouvez profiter de votre piscine à tout moment. Chez Gre, nous disposons de projecteurs qui permettent d'économiser jusqu'à 90 % de la consommation par rapport aux halogènes.

■ LED FOR SWIMMING POOLS, LOW-COST LIGHTING

Thanks to our lighting systems you can enjoy your pool at any time. At Gre we have projectors with which we can save up to 90% on consumption compared to halogens.

■ ILLUMINAZIONE A LED PER PISCINE, ILLUMINAZIONE A BASSO COSTO

Grazie ai nostri sistemi di illuminazione potrete godervi la vostra piscina in qualsiasi momento. In Gre disponiamo di proiettori con i quali possiamo risparmiare fino al 90% sui consumi rispetto alle alogene.



■ AHORRA ENERGÍA Y TIEMPO CON UN LIMPIAFONDOS

El gasto energético de un limpiafondos automático es mínimo mientras que su uso supone mas de un 20% de ahorro en el lavado del filtro a la vez que evita el desperdicio de agua.

■ ÉCONOMISER DE L'ÉNERGIE ET DU TEMPS AVEC UN NETTOYEUR DE PISCINE

La consommation d'énergie d'un nettoyeur de piscine automatique est minime, tandis que son utilisation permet d'économiser plus de 20 % du nettoyage du filtre et d'éviter le gaspillage de l'eau.

■ SAVE ENERGY AND TIME WITH A POOL CLEANER

The energy consumption of an automatic pool cleaner is minimal while its use saves more than 20% in filter cleaning and avoids wasting water.

■ RISPARMIARE ENERGIA E TEMPO CON UN PULITORE PER PISCINE

Il consumo energetico di un pulitore automatico per piscine è minimo, mentre il suo utilizzo consente di risparmiare oltre il 20% nella pulizia del filtro e di evitare lo spreco di acqua.

■ Hacia una piscina más sostenible

■ Towards a more environmentally friendly pool experience

■ CICLO DE VIDA DE UNA PISCINA DE ACERO

1. **PROVEEDORES** que trabajan con materiales reciclados y reciclables.
2. **ENERGÍA EÓLICA 100% RENOVABLE** para la fabricación de nuestras piscinas de acero, reduciendo así las emisiones.
3. **GRAN RED DE DISTRIBUCIÓN EN EUROPA** que minimiza nuestra huella de carbono.
4. Nuestros sistemas de **FILTRACIÓN** tienen el menor consumo del mercado. El uso de **CUBIERTAS ISOTÉRMICAS** durante la temporada alta (5 meses) reduce la evaporación del agua hasta en un 50%. El resto del año, una **CUBIERTA DE INVIERNO** ahorra el 95% del agua.
5. **SERVICIO POST-VENTA** con recambios originales que garantizan la longevidad y buen funcionamiento de sus piscinas. Proceso digital de atención al cliente.
6. La **VIDA MEDIA** de nuestras piscinas es de más de 10 AÑOS, y ofrecemos una garantía de 5 años para aumentar esta vida útil.
7. **ACERO: MATERIAL SOSTENIBLE**, es 100% reciclable y emite menos contaminantes que otros materiales.

■ LIFE CYCLE OF A STEEL WALL POOL

1. **SUPPLIERS** that work with recycled and recyclable materials.
2. **100% RENEWABLE WIND ENERGY** for the manufacture of our steel pools, thus reducing emissions.
3. **LARGE DISTRIBUTION NETWORK IN EUROPE** which minimises our carbon footprint.
4. Our **FILTRATION** systems have the lowest consumption on the market. The use of **ISOTHERMIC COVERS** during the high season (5 months) reduces water evaporation by up to 50%. The rest of the year, a **WINTER COVER** saves 95% of water.
5. **AFTER-SALES SERVICE** with original spare parts that guarantee the longevity and proper functioning of your pools. Digital customer service process.
6. The **AVERAGE LIFE** of our pools is more than 10 YEARS, and we offer a 5 year guarantee to increase this useful life.
7. **STEEL: SUSTAINABLE MATERIAL**, it is 100% recyclable and emits less pollutants than other materials.



■ CYCLE DE VIE DE UNE PISCINE DE PAROI EN ACIER

1. **FOURNISSEURS** qui travaillent avec des matériaux recyclés et recyclables.
2. **ÉNERGIE ÉOLIENNE 100% RENOUVELABLE** pour la fabrication de nos piscines en acier, réduisant ainsi les émissions.
3. **LARGE RÉSEAU DE DISTRIBUTION EN EUROPE** minimisant ainsi notre empreinte carbone.
4. La consommation de nos systèmes de **FILTRATION** est la plus faible du marché. L'utilisation de **BÂCHE À BULLES** pendant la haute saison (5 mois) permet de diminuer l'évaporation de l'eau à hauteur de 50%. Le reste de l'année, une **BÂCHE HIVER** permet d'économiser 95% de l'eau.
5. Un **SERVICE APRÈS-VENTE** avec des pièces détachées d'origine qui garantissent la longévité et le bon fonctionnement des piscines. Processus digitalisé pour le service clients.
6. La **DURÉE DE VIE MOYENNE** de nos piscines est de plus de 10 ANS et nous offrons une garantie de 5 ans valorisant cette durée de vie.
7. **L'ACIER: UN MATÉRIAU DURABLE**, il est recyclable à 100% et émet moins de substances polluantes que d'autres matériaux.

■ CICLO DI VITA DI UNA PISCINA CON PARETI IN ACCIAIO

1. **FORNITORI** che lavorano con materiali riciclati e riciclabili.
2. **ENERGIA EOLICA RINNOVABILE al 100%** per la produzione delle nostre piscine, con conseguente riduzione delle emissioni.
3. **RETE DI DISTRIBUZIONE AMPIA IN EUROPA** che riduce al minimo l'impronta di carbonio.
4. I nostri sistemi di **FILTRAZIONE** consumano la minor quantità di acqua sul mercato. L'uso delle **COPERTURE ISOTERMICHE** durante l'alta stagione (5 mesi) riduce l'evaporazione dell'acqua fino al 50%. Per il resto dell'anno, una **COPERTURE INVERNALE** consente di risparmiare il 95% dell'acqua.
5. **SERVIZIO POST-VENDITA** con ricambi originali che garantiscono la longevità e il buon funzionamento delle piscine. Processo di assistenza clienti digitale.
6. La **VITA MEDIA** delle nostre piscine è di oltre 10 ANNI, e offriamo una garanzia di 5 anni per migliorare questa durata.
7. **ACCIAIO: MATERIALE SOSTENIBILE**, è riciclabile al 100% ed emette meno inquinanti di altri materiali.

- Vers une expérience piscine plus respectueuse de l'environnement
- Verso un'esperienza di piscina più rispettosa dell'ambiente

CADA PISCINA DE MADERA EVITA UNA MEDIA DE 1.000 KG DE CO₂
 EACH WOODEN POOL AVOIDS AN AVERAGE OF 1,000 KG OF CO₂
 CHAQUE PISCINE EN BOIS ÉVITE EN MOYENNE L'ÉMISSION DE 1 000 KG DE CO₂
 OGNI PISCINA IN MADERA EVITA UNA MEDIA DI 1.000 KG DI CO₂

1m³
de de madera
of wood stores
de bois stocke
di legno

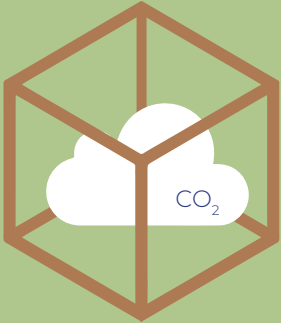

1.000kg
de CO₂
of CO₂

- Nuestras piscinas de madera reducen la huella de carbono porque la madera retiene CO₂ durante todo su ciclo de vida.
 - Nos piscines en bois réduisen l'empreinte carbone, car le bois retient le CO₂ tout au long de son cycle de vie.

- Our wooden pools reduce the carbon footprint because wood retains CO₂ throughout its life cycle.
 - Le nostre piscine in legno riducono l'impronta di carbonio perché il legno trattiene la CO₂ durante il suo ciclo di vita.



■ Certificaciones ■ Certifications ■ Certifications ■ Certificazioni



MADE IN EUROPE

■ Todas las piscinas fabricadas por Manufacturas GRE S.A. Son de origen CE - Comunidad Europea.
■ Toutes les piscines fabriquées par Manufacturas Gre S.A. sont d'Origine CE - Communauté Européenne.

■ All the pools manufactured by Manufacturas Gre S.A. are of EC - European Community origin.
■ Tutte le piscine prodotte da Manufacturas Gre S.A. sono di origine CE - Comunità Europea.

ISO 9001



■ Los procesos utilizados para el diseño, la fabricación y comercialización de piscinas desmontables de Manufacturas Gre S.A., así como la comercialización de productos asociados, están certificados siguiendo los criterios de sistema de Gestión de Calidad según la norma internacional ISO9001:2015, lo cual garantiza regularidad y control en la calidad de nuestros productos y procesos.

■ Les processus utilisés pour la conception, la fabrication et la commercialisation de piscines hors-sol de Manufacturas Gre S.A., ainsi que la commercialisation de produits associés, sont certifiés conformes aux critères du système de Gestion de Qualité, selon la norme internationale ISO9001:2015.

■ The processes used for the design, manufacturing and commercialisation of dismantlable pools by Manufacturas Gre S.A., as well as the commercialisation of associated products, are certified according to the Quality System according to the international ISO9001:2015 standard, which guarantees regularity and control in the quality of our products and processes.

■ I processi utilizzati per la progettazione, la costruzione e la vendita di piscine smontabili a marchio Manufacturas Gre S.A., oltre alla vendita di prodotti ad esse associati, sono certificati in base ai criteri del sistema di Gestione della Qualità secondo la norma internazionale ISO9001:2015, ciò garantisce la regolarità e il controllo della qualità dei nostri prodotti e dei processi produttivi.

ISO 14001



■ Gracias a la implantación de un Sistema de Gestión Ambiental según la norma internacional ISO 14001: 2015, Manufacturas Gre S.A. se posiciona como una empresa socialmente responsable. Entre otras ventajas ambientales, optimizamos la gestión de recursos y residuos, reduciendo los impactos ambientales negativos derivados de nuestra actividad o aquellos riesgos asociados a situaciones accidentales.

■ Grâce à l'implémentation d'un Système de Gestion Environnementale conformément à la norme internationale ISO14001:2015, Manufacturas Gre S.A. se positionne comme une entreprise socialement responsable. Parmi de nombreux avantages environnementaux, nous optimisons la gestion des ressources et des déchets, réduisant ainsi les impacts environnementaux négatifs et dérivés de notre activité ou les risques associés à des situations d'accidents.

■ Thanks to the implantation of an Environmental Management System according to the international ISO 14001:2015 standard, Manufacturas Gre S.A. is positioned as a socially responsible company. Among other environmental advantages, we optimise resources and residues, reducing negative environmental impact derived from our activity or those risks associated to accidental situations.

■ Grazie all'introduzione di un Sistema di Gestione Ambientale secondo la norma internazionale ISO 14001:2015, Manufacturas Gre S.A. si classifica tra le aziende socialmente responsabili. Ciò comporta vantaggi per l'ambiente come l'ottimizzazione della gestione delle risorse, la riduzione degli impatti ambientali negativi derivanti dall'attività di produzione o dei rischi associati a eventi accidentali.

ARBITRAJE DE CONSUMO · CONSUMER ARBITRATION ARBITRAGE DE CONSOMMATION · ARBITRATO DI CONSUMO



■ Manufacturas Gre S.A. está adherido a la Junta Arbitral de Consumo como muestra de predisposición a la solución amistosa de cualquier tipo de reclamación por parte de sus clientes..

■ Manufacturas Gre S.A. est membre du bureau d'Arbitrage de Consommation, comme preuve de sa prédisposition à trouver une solution amiable face à tout type de réclamation de la part de ses clients.

■ Manufacturas Gre S.A. is adhered to the Consumer Arbitration Directorate evidencing predisposition to a friendly solution to any type of reclamation from its clients.

■ Manufacturas Gre S.A. aderisce alla Giunta Arbitrale di Consumo come segnale di predisposizione alla soluzione amichevole di qualsiasi tipo di reclamo da parte dei propri clienti.

CE



■ Los productos distribuidos por Manufacturas Gre S.A. con el marcado CE cumplen todos los requisitos legales vigentes en Europa.

■ Les produits distribués par Manufacturas Gre S.A. et dotés du marquage CE répondent à toutes les obligations légales en vigueur en Europe.

■ The products distributed by Manufacturas Gre S.A., with the CE marking comply with all the legal requirements in force in Europe.

■ I prodotti distribuiti da Manufacturas Gre S.A. con il marchio CE rispettano tutti i requisiti legali vigenti in Europa.



EN 16582-1, EN 16582-3, EN 16713-1

- Estas certificaciones garantizan que las piscinas, filtros y escaleras fabricados y/o distribuidos por Manufacturas Gre S.A. cumplen con las normativas de seguridad establecidas.
- Ces certifications garantissent que les piscines, les filtres et les échelles fabriqués et/ou distribués par Manufacturas Gre S.A. respectent les normes de sécurité établies.

- These certifications guarantee that the pools, filters and stepladders manufactured and/or commercialised by Manufacturas Gre S.A. comply with the established safety regulations.
- Queste certificazioni garantiscono che le piscine, i filtri e le scalette prodotti e/o distribuiti da Manufacturas Gre S.A. rispettano le normative di sicurezza previste.



ECOEMBEES

- Manufacturas Gre S.A. está adherida a un sistema de recogida y reciclaje selectivo de los materiales que pone en el mercado con el fin último de preservar el medio ambiente.
- Manufacturas Gre S.A. est membre d'un système de collecte et de recyclage sélectif des matériaux qu'elle met sur le marché, dans le but de préserver l'environnement.

- Manufacturas Gre S.A. is adhered to a system for the selective collection and recycling of the materials it puts on the market in order to conserve the environment.
- Manufacturas Gre S.A. aderisce a un sistema di raccolta differenziata e riciclaggio dei materiali immessi sul mercato, in un'ottica di preservazione dell'ambiente.



REACH

- Manufacturas Gre S.A. cumple con el reglamento Reach asegurando que todas las sustancias químicas que comercializa están registradas
- Manufacturas Gre S.A. respecte le règlement Reach, qui garantit que toutes les substances chimiques qu'elle commercialise sont enregistrées.

- Manufacturas Gre S.A. complies with the Reach regulation ensuring that all the chemical substances it commercialises are registered.
- Manufacturas Gre S.A. rispetta il regolamento Reach garantendo la registrazione di tutte le sostanze chimiche immesse sul mercato dall'azienda.

ROHS

- Manufacturas Gre S.A. cumple esta directiva para proteger el medio ambiente y la salud de las personas, evitando el uso de determinadas sustancias en aparatos eléctricos y electrónicos.
- Manufacturas Gre S.A. respecte cette directive afin de protéger l'environnement et la santé des personnes, évitant ainsi l'utilisation de substances déterminées dans les appareils électriques et électroniques.

- Manufacturas Gre S.A. complies with this directive to protect the environment and health of persons, avoiding the use of determined substances in electrical and electronic devices.
- Manufacturas Gre S.A. rispetta questa normativa per proteggere l'ambiente e la salute delle persone, evitando l'utilizzo di determinate sostanze su dispositivi elettrici ed elettronici.

RoHS



PEFC

- Manufacturas Gre S.A. cumple con los requisitos del Estándar de Cadena de Custodia de Productos Forestales PEFC ST 2002:2013.
- Manufacturas Gre S.A. respecte les conditions du Standard de la Chaîne de Contrôle de Produits Forestiers PEFC ST 2002:2013.

- Manufacturas Gre S.A. complies with the requirements of the Programme for the Endorsement of Forest Certification PEFC ST 2002:2013.
- Manufacturas Gre S.A. rispetta i requisiti previsti dallo Standard della catena di custodia dei prodotti forestali PEFC ST 2002:2013.

BOIS DE FRANCE



- La etiqueta BOIS DE FRANCE garantiza el origen de la materia prima de madera utilizada en los productos acabados, así como el lugar de fabricación, montaje o comercialización de estos productos. Garantizando así dos criterios:
 - La madera procede de bosques franceses;
 - La transformación, el montaje, el tratamiento y el embalaje de los productos se realizan en Francia.
- Le label BOIS DE FRANCE garantit l'origine de la matière première à base de bois utilisée dans les produits finis ainsi que le lieu de fabrication, d'assemblage ou de commercialisation de ces produits garantissant ainsi deux critères:
 - Le bois est issu des forêts françaises;
 - La transformation, l'assemblage, le traitement et l'emballage des produits sont effectués en France.

- The BOIS DE FRANCE label guarantees the origin of the raw wood used in the finished products, as well as the place of manufacture, assembly or marketing of these products. It thus guarantees two criteria:
 - The wood comes from French forests;
 - The processing, assembly, wood treatment and packaging of the products are carried out in France.
- L'etichetta BOIS DE FRANCE garantisce l'origine della materia prima Madeira utilizzata nei prodotti finiti, nonché il luogo di fabbricazione, assemblaggio o commercializzazione di questi prodotti. Garantendo così due criteri:
 - Madeira proviene dalle foreste francesi;
 - La trasformazione, l'ass emblaggio, il trattamento e il confezionamento dei prodotti vengono effettuati in Francia.



wooden pools



■ PISCINAS DE MADERA

LINER: tratamiento Anti-ultravioleta que retrasa el envejecimiento del P.V.C

MADERA: fabricadas en Francia en pino silvestre francés y con tratamiento en autoclave clase IV que garantiza la resistencia de la madera contra el ataque de insectos y pudrimiento. 10 años de garantía sobre la madera.

■ PISCINE BOIS

LINER : traitement anti-ultraviolets contre le vieillissement du P.V.C.

BOIS : de fabrication française et réalisées à partir de madriers en pin (origine France), nos piscines bois bénéficient d'un traitement par autoclave de classe IV, ce qui garantit une résistance au pourrissement et aux attaques d'insectes xylophages. 10 ans de garantie sur les composants bois de la piscine.

■ WOODEN POOLS

LINER: anti-ultraviolet treatment to slow down P.V.C aging.

WOODEN: manufactured in France with pine boards (originating in France), with a class IV autoclave treatment which guarantees its resistance to decay and xylophagous insects attack.

■ PISCINA IN LEGNO

LINER: Trattamento Anti-ultravioletti - Ritarda l'invecchiamento del P.V.C.

LEGNO: Prodotte in Francia in pino silvestre francese con trattamento in autoclave classe IV che garantisce la resistenza del legno agli insetti e al deterioramento. 10 anni di garanzia sulle parti in legno.



■ LA MADERA, UNA HISTORIA ■ THE WOOD, A STORY ■ LE BOIS, UNE HISTOIRE ■ IL BOSCO, UNA STORIA

■ PINO SILVESTRE

Manufacturas Gre presenta piscinas con estructuras de madera de **pino silvestre**. Con un planteamiento de desarrollo sostenible, **Manufacturas Gre** cuenta **exclusivamente** con proveedores **locales en Francia**, de bosques de pinos denominados «del país». Asimismo, limitamos el transporte y las emisiones de gases de efecto invernadero. El PINO es la esencia de la clase de uso del autoclave IV, que garantiza resistencia frente a la podredumbre y a los insectos xilófagos.

El denominado pino «del país» presenta **más albura** que los pinos procedentes de bosques septentrionales. Además, ofrece **una zona de impregnación más significativa**, lo que asegura una vida útil superior a los diez años debido a una impregnación profunda en el autoclave. Este último es el único procedimiento normalizado y garantizado que aporta garantías a la durabilidad.

■ PINO SILVESTRE

Manufacturas Gre è lieta di presentare le piscine con struttura in legno di **pino silvestre**. Con un approccio rivolto allo sviluppo sostenibile, **Manufacturas Gre** si affida **esclusivamente** a fornitori **locali in Francia**, di legno proveniente da foreste di pini "autoctoni".

Vengono limitati il trasporto e le emissioni di gas serra. Il PINO subisce un trattamento in autoclave classe IV, che garantisce resistenza al deterioramento e agli insetti xilofagi. Il cosiddetto pino "autoctono" presenta una quantità maggiore di **alburno** rispetto ai pini provenienti dalle foreste settentrionali. Offre inoltre **una maggiore area di impregnazione**, che garantisce una durata utile superiore a dieci anni grazie a una profonda impregnazione in autoclave. Quest'ultima è l'unica procedura standardizzata e garantita che apporta garanzie di durabilità.



■ SCOTS PINE

Manufacturas Gre presents pools with **Scots pine** wood structures. With its proposal for sustainable development, **Manufacturas Gré** exclusively uses **local French** suppliers, from forests of pine wood denominated «local pine». Likewise, we limit transport and emissions of greenhouse gases. PINE is the essence of the class used in Autoclave IV that guarantees resistance against rot and xylophagous insects.

The so-called «local pine» has **more whiteness** than pines coming from northern forests. In addition, it offers **a more significant impregnation area**, which assures a useful life above ten years due to deeper impregnation in the autoclave. This latter is the only standardised and guaranteed process proving guaranteed durability.

■ LE PIN SYLVESTRE

Manufacturas Gré propose des piscines à ossature bois en **pin sylvestre**. Dans une logique de développement durable, **Manufacturas Gré** s'approvisionne **localement et exclusivement en France**, auprès de forêts de pin dit « de pays ». Nous limitons ainsi le transport et les émissions de gaz à effet de serre.

Le PIN est l'essence idéale pour la classe d'emploi autoclave IV, garantissant une résistance au pourrissement et aux attaques d'insectes xylophages. Le pin dit « de pays » présente **plus d'aubiers** que les pins des forêts du nord. Il offre ainsi **une zone d'impregnation plus importante** lui garantissant une durée de service supérieure à 10 ans grâce à l'impregnation profonde en autoclave. Ce dernier est le seul procédé normalisé et certifié apportant des garanties dans la durée.



■ TRATAMIENTO AUTOCLAVE

El tratamiento en el autoclave es **la mejor solución** para proteger las maderas expuestas de forma directa a la intemperie o en contacto con el suelo y consiste en **impregnar conservantes hasta el núcleo de la madera**.

■ LE TRAITEMENT AUTOCLAVE

Le traitement par autoclavage est **la meilleure solution** pour protéger les bois directement exposés aux intempéries ou en contact avec le sol et consiste à **imprégner des agents de conservation jusqu'au cœur du bois**.



■ AUTOCLAVE TREATMENT

Treatment in the autoclave is **the best solution** for protecting wood directly exposed to outdoor weather or in contact with the ground and consists of **impregnating preservatives into the core of the wood**.

■ TRATTAMENTO IN AUTOCLAVE

Il trattamento in autoclave è **la soluzione migliore** per proteggere il legno esposto direttamente alle intemperie o a contatto con il terreno e consiste **nell'impregnare conservanti nel nucleo del legno**.



■ CERTIFICACIONES

PRODUCTOS CERTIFICADOS POR **PEFC** (Programa europeo de certificación forestal). Licencia número: PEFC/14-38-00166.

Pioneros en la certificación forestal en Francia, PEFC acoge en la actualidad 8,1 millones de hectáreas, 62000 propietarios y 3000 empresas del sector maderero forestal (explotaciones, aserraderos, industrias de transformación, construcciones, intermediarios comerciales, distribuidores, industrias papeleras, imprentas, editoriales, etc.). En conjunto, aportan al consumidor la garantía de que el producto que lleve la marca PEFC se enmarca en una estrategia responsable de gestión forestal sostenible.

■ CERTIFICATION

PRODUITS LABELLISÉS **PEFC**. (Programme Européen des Forêts Certifiées). N° licence : PEFC/14-38-00166.

Pionnier de la certification forestière en France, PEFC représente aujourd'hui 8.1 millions d'hectares, 62000 propriétaires et 3000 entreprises de la filière forêt-bois (exploitants, scieries, transformateurs, constructeurs, négociants, artisans, distributeurs, papetiers, imprimeurs, éditeurs...). Ensemble, ils apportent au consommateur la garantie qu'un produit portant la marque PEFC s'inscrit dans une démarche responsable de gestion durable de la forêt.

www.pefc.es / www.pefc-france.org

- Nuestra madera procede de bosques gestionados de forma responsable y sostenible, certificados como PEFC™
- Our wood comes from responsibly and sustainably managed forests, certified with PEFC™
- Notre bois est issu de forêts gérées de façon responsable et durable, certifiées PEFC™
- Il nostro legno proviene da foreste gestite in modo responsabile e sostenibile, certificate come PEFC™



■ INSTALACIÓN

Libre elección de instalación: en superficie, semienterrada o enterrada. En estos dos últimos casos, es obligatorio acondicionar un drenaje en todo el perímetro del vaso (consultar el aviso).

■ IMPLANTATION

Implantation libre de choix : hors-sol, semi-enterrée jusqu'à complètement enterrée. En cas d'implantation semi-enterrée ou totalement enterrée, il est impératif de réaliser un drainage sur toute la périphérie du bassin (cf notice).

■ CERTIFICATION

PRODUCTS CERTIFIED BY **PEFC** (European programme for forestry certification). License number: PEFC/14-38-00166.

Pioneers in forestry certification in France, PEFC currently includes 8.1 million hectares, 62,000 owners, and 3,000 forest timber sector companies (exploitations, sawmills, transformation industries, constructions, commercial intermediaries, distributors, paper industries, printers, publishers, etc.). Overall, they provide the consumer with the guarantee that the product with PEFC marking is framed within a responsible strategy of sustainable forest management.

■ CERTIFICAZIONE

PRODOTTI CERTIFICATI DAL **PEFC**. (Programma europeo di certificazione forestale). Licenza numero: PEFC/14-38-00166.

Pionieri nella certificazione forestale in Francia, PEFC conta attualmente 8,1 milioni di ettari, 62.000 proprietari e 3.000 aziende nel settore del legno (aziende agricole, segherie, industrie di trasformazione, settore edile, intermediari commerciali, distributori, cartiere, stamperie, editorie, ecc.). Uniti nell'intento di offrire ai consumatori la garanzia che il prodotto a marchio PEFC faccia parte di una strategia responsabile per la gestione sostenibile delle foreste.

■ INSTALLATION

Free choice of installation: above ground, semi in-ground or in-ground. In these two latter cases, there must be drainage in the entire perimeter of the pool (check warning).

■ INSTALLAZIONE

Libera installazione: superficiale, semi-interrata o interrata. In questi ultimi due casi, è obbligatorio predisporre un drenaggio attorno al perimetro della vasca (consultare le specifiche indicazioni).

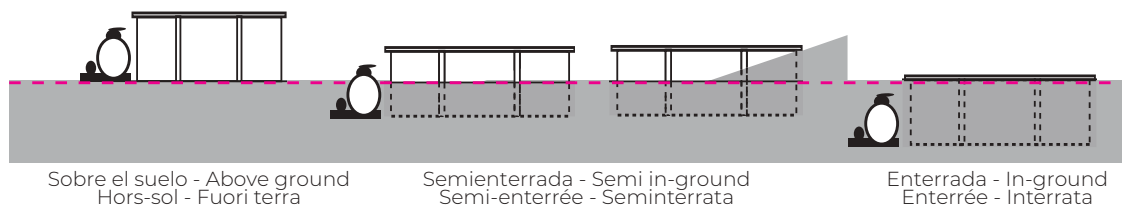

- Todas las dimensiones de nuestras piscinas se presentan con una tolerancia de +/- 3 %
- All dimensions of our pools are given with a tolerance of +/- 3 %
- Toutes les dimensions de nos piscines sont données avec une tolérance de +/- 3 %
- Tutte le dimensioni delle nostre piscine vengono indicate con una tolleranza di +/- 3 %

■ Piscinas de madera ■ Wooden pools
 ■ Les piscines en bois ■ Piscine in legno



- Disfruta del verano con las piscinas de madera Gre
- Enjoy your summer with Gre wooden pools
- Profitez de l'été avec les piscines en bois Gre
- Godetevi l'estate con le piscine in legno Gre

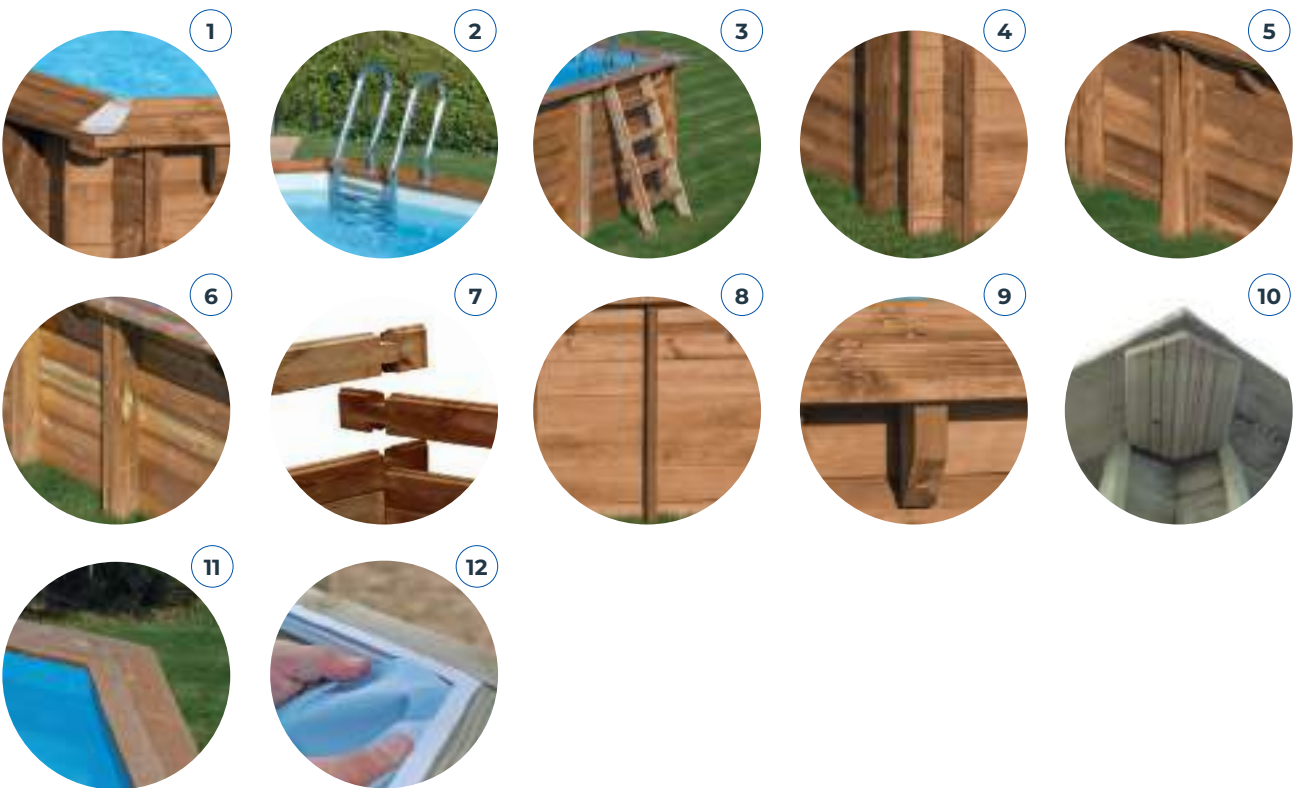
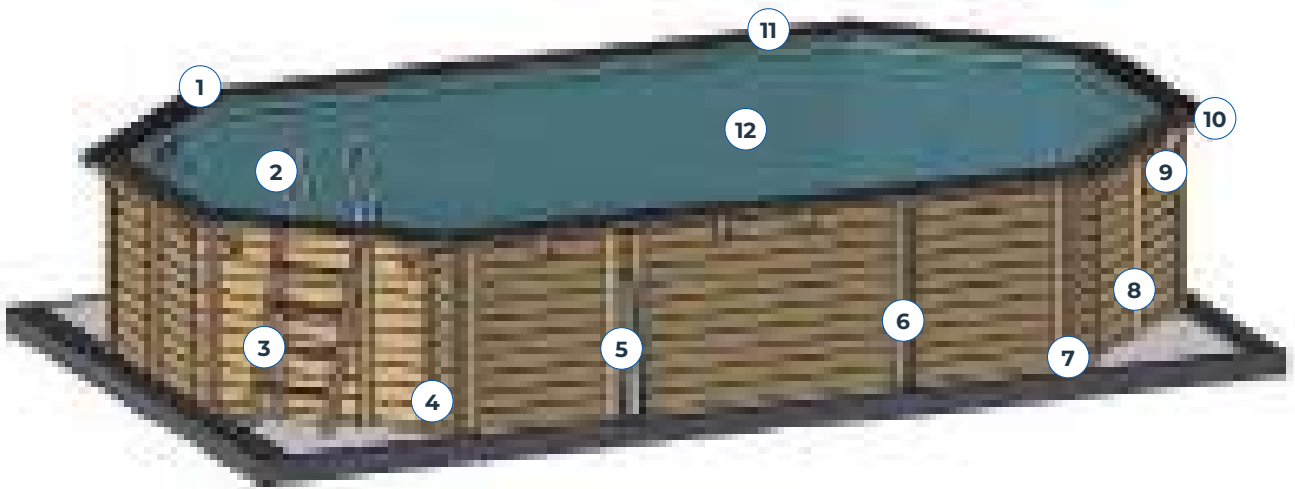

■ PISCINAS DE MADERA

1: Embellecedor de esquinas inoxidable: Según el modelo **2: Escalera inoxidable:** Fija - 3 Escalones antideslizantes **3: Escalera de madera:** Posibilidad de reajustar la escalera de madera según la altura de la piscina **4: Embellecedor angular:** El revestimiento de madera en los extremos de los tablonos perfecciona la estética del vaso **5: Cuñas metálicas:** Cuñas de refuerzo para fijar sobre la losa de hormigón **6: Vigas:** Vigas metálicas para encastrar en la losa de hormigón o sistema de omegas (los de hormigón opcional) **7: Conjunto de ranura y lengüeta:** Encaje de tablonos entre ellos mediante cruce de los extremos - Ranura y lengüeta sencillas para facilitar el montaje y así evitar el riesgo de rotura **8: Refuerzos verticales:** Resistencia vertical gracias a los refuerzos de madera **9: Tacos de madera:** Los tacos se emplean para sostener las playas **10: Tacos bajo playa:** Permiten reforzar la instalación de las playas en las esquinas **11: Playas de madera:** De pino silvestre tratado en autoclave de clase IV - Simple (190 mm) o doble (2 x 145 mm) según el modelo - Grosor de 28 mm o de 36 mm según el modelo **12: Liner:** Perfil colgate.

■ PISCINE BOIS

1: Caches angles: Inox Selon modèle **2: Échelle Inox:** Amovible - 3 marches anti-dérapantes **3: Échelle Bois:** Possibilité de réajuster l'échelle bois selon la hauteur du bassin **4: Cache L:** Un habillage bois aux extrémités des madriers vient parfaire l'esthétisme du bassin **5: Sabots:** Renforts sabot à fixer sur la dalle béton **6: Berceaux:** Berceaux métalliques à noyer dans la dalle béton ou renforts enterrés (dalle béton facultative) **7: Assemblage:** Rainure languette Emboîtement des madriers les uns sur les autres en se croisant à leurs extrémités - Simple rainure / languette pour faciliter le montage et éviter ainsi le risque de casse **8: Renforts verticaux:** Résistance verticale grâce aux renforts bois **9: Consoles:** Les consoles sont destinées à soutenir les margelles **10: Plaques sous margelles:** Permet de renforcer l'assemblage des margelles dans les angles **11: Margelles Bois:** En pin Sylvestre traité autoclave classe IV - Simple (190 mm) ou double (2 x 145 mm) selon modèle - Épaisseur 28 mm ou 36 mm selon modèle **12: Liner:** Baguettes Hung

■ WOODEN POOLS

1: Stainless steel corners: According to model **2: Stainless steel ladder:** Fixed - 3 non-slip steps **3: Wood ladder:** Possibility of readjusting the wood ladder according to the height of the pool. **4: Angular finishing:** The wood coating at the ends of the boards provides greater aesthetics to the pool **5: Wedges:** Reinforcement wedges for fixing on concrete slab **6: Nerves:** Metallic nerves for embedding in concrete slab or omega system (optional concrete slab) **7: Tongue and groove series:** Boards are fitted to each other by a cross at the end - Simple tongue and groove facilitating assembly and that way avoiding risk of breakage. **8: Vertical reinforcements:** Vertical resistance thanks to wood reinforcements **9: Corbels:** Corbels are used to sustain the edges **10: Plates under edges:** Allow reinforcing the installation of edges on the corners **11: Wood edges:** Made from Scots pine treated in class IV autoclave - Single (190 mm) or double (2 x 145 mm) according to model - Thickness of 28 mm or of 36 mm according to model **12: Liner:** Baguettes Hung

■ PISCINA IN LEGNO

1: Rivestimento per angoli in acciaio inox: In base al modello **2: Scaletta in acciaio inox:** Fissa - 3 scalini antiscivolo **3: Scaletta in legno:** Possibilità di regolare la scaletta in base all'altezza della vasca **4: Rivestimento angolare:** Il rivestimento in legno posto alle estremità dei pannelli perfeziona l'estetica della vasca **5: Cunei:** Cunei di rinforzo da fissare sulla lastra in calcestruzzo **6: Nervature:** Nervature metalliche da incastrare nella lastra in calcestruzzo o sistema omega (basamento di calcestruzzo opzionale) **7: Set composto da scanalatura e linguetta:** Incastrare i pannelli tra loro incrociando le estremità - Scanalatura e linguetta per facilitare il montaggio evitando il rischio di rottura **8: Rinforzi verticali:** Resistenza verticale grazie ai rinforzi in legno **9: Mensole:** Le mensole vengono utilizzate per sostenere i bordi **10: Piastre poste sotto al bordo:** Permettono di rinforzare i bordi negli angoli **11: Bordi in legno:** Realizzati in legno di pino silvestre con trattamento in autoclave in classe IV - Semplice (190 mm) o doppio (2 x 145 mm) a seconda del modello - Spessore 28 mm o 36 mm a seconda del modello **12: Liner:** Baguettes Hung

■ REFUERZOS DE ESTRUCTURA ■ STRUCTURAL REINFORCEMENTS ■ RENFORTS DE STRUCTURE ■ RINFORZI STRUTTURALI

■ SISTEMA DE OMEGAS ■ OMEGA SYSTEM ■ RENFORTS ENTERRÉS ■ SISTEMA OMEGA

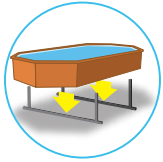

- Viga de acero enterrada de 15x15 cm. Es necesario excavar y preparar el terreno para nivelarlo. Losa de hormigón opcional.
- 15x15 cm buried steel beam. You should excavate and prepare the land for levelling. Optional concrete slab.
- Poteaux en acier à enterrer de 15x15 cm. Il est nécessaire de décaper votre terrain et de mettre le terrassement de niveau. Dalle béton facultative.
- Barra di acciaio interrata da 15x15 cm. È necessario scavare e preparare il terreno per livellarlo. Basamento di calcestruzzo opzionale.



■ Losa de hormigón opcional ■ Concrete slab is optional ■ Dalle béton facultative ■ Lastra di calcestruzzo opzionale



- Instalación
- Installation
- Installation
- Installazione

■ CUÑA METÁLICA ■ METALLIC WEDGE ■ SABOTS ■ CUNEO METALLICO



- Es obligatorio realizar una losa de hormigón, de 15 cm de espesor mínimo, previamente al montaje de la piscina para fijar las cuñas metálicas. Antes de montar la piscina, consultar el manual de instalación y el video de montaje.
- The wedge is fixed over the concrete slab. In such a way, it is mandatory to make the slab, of 15 cm minimum, beforehand to the assembly of the pool. Before assembling pool, check installation warning and assembly video.
- Le sabot vient se fixer sur la dalle en béton. Il est donc impératif de réaliser une dalle de 15 cm minimum avant le montage du bassin. Préalablement au montage du bassin cf. notice de montage et vidéo de montage.
- Il cuneo metallico si fissa sopra il massetto di cemento. Quindi è obbligatorio realizzare il massetto dello spessore minimo di 15 cm prima del montaggio della piscina. Prima di montare la vasca consultare le indicazioni e il video di montaggio.



■ Losa de hormigón obligatoria ■ Concrete slab is mandatory ■ Dalle béton obligatoire ■ Lastra di calcestruzzo obbligatorio



- Instalación
- Installation
- Installation
- Installazione

■ VIGAS METÁLICAS (SISTEMA IPE) ■ BURIED STEEL BEAMS (IPE SYSTEM)
 ■ BERCEAUX (IPE) ■ BARRA DI ACCIAIO (SISTEMA IPE)

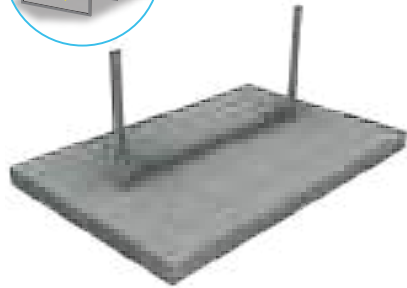
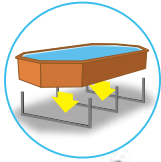

■ Las vigas metálicas se encastran en la losa de hormigón, con un espesor mínimo de 17 cm. Su colocación forma parte del proceso de montaje de la estructura (consultar el manual de instalación).

■ Buried steel beams are embedded in the concrete slab, with a minimum thickness of 17 cm. Their installation is part of the structure assembly process (check installation warning)

■ Les berceaux métalliques sont à noyer dans la dalle béton, épaisseur minimum de 17 cm). Leur pose fait partie intégrante du montage de la structure (cf. notice de montage).

■ La barra di acciaio vengono incassate nella lastra di calcestruzzo, con uno spessore minimo di 17cm. Il loro posizionamento fa parte del processo di assemblaggio della struttura (vedere indicazioni per il montaggio).



■ Losa de hormigón obligatoria ■ Concrete slab is mandatory ■ Dalle béton obligatoire ■ Lastra di calcestruzzo obbligatorio



- Instalación
- Installation
- Installation
- Installazione



wooden pools



REFERENCIA · REFERENCE ·
RÉFÉRENCE · RIFERIMENTO



EXTERIORES · OUTSIDE ·
EXTÉRIEURES · ESTERNO



INTERIORES · INSIDE ·
INTÉRIEURES · INTERNI



VOLUMEN DE AGUA · WATER VOLUME ·
VOLUME D'EAU · VOLUME DI ACQUA



LÍNEA DE AGUA · WATER LINE ·
LIGNE D'EAU · LINEA DELL'ACQUA



ESPESOR MADERA · WOOD THICKNESS ·
ÉPAISSEUR MADRIER · DIMENSIONE



MACHIHEMBRADO · TONGUE AND GROOVE ·
ASSEMBLAGE RAINURES LANGUETTES · INCASTRO

PLAYAS · EDGES · MARGELLES · BORDI



ANCHO · WIDTH · LARGEUR · LARGHEZZA

ESPESOR · THICKNESS ·
ÉPAISSEUR · DIMENSIONE



EMBELLECEDORES METÁLICOS · METAL COVERS ·
CACHES ANGLES INOX · PROTEZIONE METALLICO



LINER



FILTRACIÓN · FILTRATION · FILTRO

PROTECTOR · PROTECTOR · FEUTRE · PROTEZIONE



FONDO · FLOOR · FOND



PARED · WALL · PAROI · PARETE



ESCALERA INTERIOR · INSIDE LADDER ·
ÉCHELLE INTÉRIEURE · SCALA INTERNA



ESCALERA EXTERIOR · OUTSIDE LADDER ·
ÉCHELLE EXTÉRIEURE · SCALA ESTERNA



ESTRUCTURA · STRUCTURE ·
STRUCTURE · STRUTTURA



TERRENO · TERRAIN · LAND · TERRENO



PALET 1 ACCESORIOS · ACCESSORIES ·
ACCESSOIRES · ACCESSORI



PALET 2 MADERA · WOOD · BOIS · LEGNO



CÓDIGO · EAN CODE ·
GENCOD · CODICE A BARRE

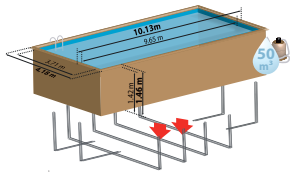

MINT

788032

10,10 x 4,18 x H. 1,46 m

9,65 x 3,71 x H. 1,42 m

50 m³

1,36 m

46 mm



Double

14,5 cm x 2 = 29 cm

3,6 cm



14,5 cm

75/100

FILTRO DE ARENA · SAND FILTER · FILTRATION À SABLE · FILTRO A SABBIA

10 m³/h - 2 skimmer

Espesor · Thickness · Épaisseur · Dimensione: 200 g/m²



ACERO INOXIDABLE · STAINLESS STEEL · ACIER INOXYDABLE · ACCIAIO INOX

MADERA · WOOD · BOIS · LEGNO



VIGAS METÁLICAS · BURIED STEEL BEAM · BERCEAUX METALLIQUES · BARRA DI ACCIAIO (IPE SYSTEM)

Losa de hormigón obligatoria · Obligatory concrete slab · Dalle béton Obligatoire · Basamento di calcestruzzo obbligatorio

1053 x 459 x H 17 cm
8,24 m³

200 x 80 x 78 cm - 612 kg

405 x 111 x 92 cm - 2555 kg



3 605217 880321



BRAGA

790207

● LDD: **790207D**

8,15 x 4,20 x H. 1,46 m

7,67 x 3,73 x H. 1,42 m

37,1 m³

1,36 m

46 mm



Double

14,5 cm x 2 = 29 cm

3,6 cm



14,5 cm

75/100

FILTRO DE ARENA · SAND FILTER · FILTRATION À SABLE · FILTRO A SABBIA

10 m³/h - 2 skimmer

Espesor · Thickness · Épaisseur · Dimensione: 200 g/m²



ACERO INOXIDABLE · STAINLESS STEEL · ACIER INOXYDABLE · ACCIAIO INOX

MADERA · WOOD · BOIS · LEGNO



VIGAS METÁLICAS · BURIED STEEL BEAM · BERCEAUX METALLIQUES · BARRA DI ACCIAIO (IPE SYSTEM)

Losa de hormigón obligatoria · Obligatory concrete slab · Dalle béton Obligatoire · Basamento di calcestruzzo obbligatorio

856 x 461 x H 17 cm
6,72 m³

200 x 80 x 100 cm - 481 kg

405 x 111 x 77 cm - 2201 kg



3 605217 902078



3 605217 902207

wooden pools



790206 EVORA



800009 EVORA PLUS

REFERENCIA · REFERENCE ·
RÉFÉRENCE · RIFERIMENTO



EXTERIORES · OUTSIDE ·
EXTÉRIEURES · ESTERNO



INTERIORES · INSIDE ·
INTÉRIEURES · INTERNI



VOLUMEN DE AGUA · WATER VOLUME ·
VOLUME D'EAU · VOLUME DI ACQUA



LÍNEA DE AGUA · WATER LINE ·
LIGNE D'EAU · LINEA DELL'ACQUA



ESPESOR MADERA · WOOD THICKNESS ·
ÉPAISSEUR MADRIER · DIMENSIONE



MACHIHEMBRADO · TONGUE AND GROOVE ·
ASSEMBLAGE RAINURES LANGUETTES · INCASTRO



PLAYAS · EDGES · MARGELLES · BORDI

ANCHO · WIDTH · LARGEUR · LARGHEZZA

ESPESOR · THICKNESS ·
ÉPAISSEUR · DIMENSIONE



EMBELLECEDORES METÁLICOS · METAL COVERS ·
CACHES ANGLES INOX · PROTEZIONE METALLICO



LINER



FILTRACIÓN · FILTRATION · FILTRO



PROTECTOR · PROTECTOR · FEUTRE · PROTEZIONE

FONDO · FLOOR · FOND



PARED · WALL · PAROI · PARETE



ESCALERA INTERIOR · INSIDE LADDER ·
ÉCHELLE INTÉRIEURE · SCALA INTERNA



ESCALERA EXTERIOR · OUTSIDE LADDER ·
ÉCHELLE EXTÉRIEURE · SCALA ESTERNA



ESTRUCTURA · STRUCTURE ·
STRUCTURE · STRUTTURA



TERRENO · TERRAIN · LAND · TERRENO



PALET 1 ACCESORIOS · ACCESSORIES ·
ACCESSOIRES · ACCESSORI



PALET 2 MADERA · WOOD · BOIS · LEGNO



CÓDIGO · EAN CODE ·
GENCOD · CODICE A BARRE



EVORA

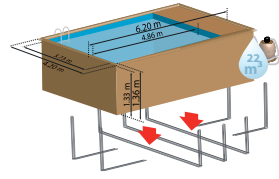

EVORA PLUS

790206 LDD: 790206D	800009
6,20 x 4,20 x H. 1,33 m	6,20 x 4,20 x H. 1,36 m
5,70 x 3,73 x H. 1,30 m	4,86 x 3,73 x H. 1,33 m
24,1 m ³	22 m ³
1,20 m	1,23 m
46 mm	46 mm
✓ 14,5 cm	- 19 cm
Double 14,5 cm x 2 = 29 cm 2,8 cm	Double 14,5 cm x 2 = 29 cm 2,8 cm
✓	✓
75/100	75/100
FILTRO DE ARENA · SAND FILTER · FILTRATION À SABLE · FILTRO A SABBIA	
8 m ³ /h	8 m ³ /h
Espesor · Thickness · Épaisseur · Dimensione: 200 g/m ²	
✓ ✓	✓ ✓
ACERO INOXIDABLE · STAINLESS STEEL · ACIER INOXYDABLE · ACCIAIO INOX	
MADERA · WOOD · BOIS · LEGNO	
 VIGAS METÁLICAS · BURIED STEEL BEAM · BERCEAUX METALLIQUES · BARRA DI ACCIAIO (IPE SYSTEM)	
Losa de hormigón obligatoria · Obligatory concrete slab · Dalle béton Obligatoire · Basamento di calcestruzzo obbligatorio	
659 x 461 x H 17 cm 5,17 m ³	659 x 461 x H 17 cm 5,17 m ³
200 x 80 x 100 cm - 400 kg	200 x 80 x 100 cm - 425 kg
405 x 111 x 77 cm - 1668 kg	405 x 112 x 72 cm - 2040 kg
 3 605217 902061  3 605217 902191	 8 412081 313870

wooden pools



KPBRC620 MANGO



7900962 MARBELLA 2

REFERENCIA · REFERENCE ·
RÉFÉRENCE · RIFERIMENTO



EXTERIORES · OUTSIDE ·
EXTÉRIEURES · ESTERNO



INTERIORES · INSIDE ·
INTÉRIEURES · INTERNI



VOLUMEN DE AGUA · WATER VOLUME ·
VOLUME D'EAU · VOLUME DI ACQUA



LÍNEA DE AGUA · WATER LINE ·
LIGNE D'EAU · LINEA DELL'ACQUA



ESPESOR MADERA · WOOD THICKNESS ·
ÉPAISSEUR MADRIER · DIMENSIONE



MACHIHEMBRADO · TONGUE AND GROOVE ·
ASSEMBLAGE RAINURES LANGUETTES · INCASTRO



PLAYAS · EDGES · MARGELLES · BORDI

ANCHO · WIDTH · LARGEUR · LARGHEZZA

ESPESOR · THICKNESS ·
ÉPAISSEUR · DIMENSIONE



EMBELLECEDORES METÁLICOS · METAL COVERS ·
CACHES ANGLES INOX · PROTEZIONE METALLICO



LINER



FILTRACIÓN · FILTRATION · FILTRO



PROTECTOR · PROTECTOR · FEUTRE · PROTEZIONE

FONDO · FLOOR · FOND



PARED · WALL · PAROI · PARETE



ESCALERA INTERIOR · INSIDE LADDER ·
ÉCHELLE INTÉRIEURE · SCALA INTERNA



ESCALERA EXTERIOR · OUTSIDE LADDER ·
ÉCHELLE EXTÉRIEURE · SCALA ESTERNA



ESTRUCTURA · STRUCTURE ·
STRUCTURE · STRUTTURA



TERRENO · TERRAIN · LAND · TERRENO



PALET 1 ACCESORIOS · ACCESSORIES ·
ACCESSOIRES · ACCESSORI



PALET 2 MADERA · WOOD · BOIS · LEGNO



CÓDIGO · EAN CODE ·
GENCOD · CODICE A BARRE

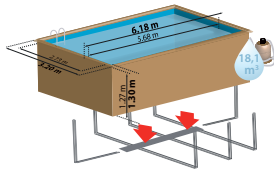

MANGO

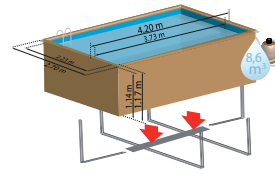

MARBELLA 2

<p>KPBRC620</p>	<p>7900962 LDD: 7900962D</p>
6,18 x 3,20 x H. 1,30 m	4,20 x 2,70 x H. 1,17 m
5,68 x 2,73 x H. 1,27 m	3,73 x 2,23 x H. 1,14 m
18,1 m ³	8,6 m ³
1,17 m	1,07 m
46 mm	46 mm
<p>✓ 14,5 cm</p>	<p>- 19 cm</p>
<p>Double 14,5 cm x 2 = 29 cm 2,8 cm</p>	<p>Double 14,5 cm x 2 = 29 cm 2,8 cm</p>
<p>✓</p>	<p>✓</p>
60/100	75/100
<p>FILTRO DE ARENA · SAND FILTER · FILTRATION À SABLE · FILTRO A SABBIA</p>	
6 m ³ /h	4 m ³ /h
<p>Espeor · Thickness · Épaisseur · Dimensione: 200 g/m²</p>	
<p>✓ ✓</p>	<p>✓ ✓</p>
<p>ACERO INOXIDABLE · STAINLESS STEEL · ACIER INOXYDABLE · ACCIAIO INOX</p>	
<p>MADERA · WOOD · BOIS · LEGNO</p>	
<p> SISTEMA DE OMEGAS · OMEGA SYSTEM · RENFORTS ENTERRÉS · SISTEMA OMEGA</p>	
<p>Losa de hormigón opcional · Optional concrete slab · Dalle béton facultative · Basamento di calcestruzzo opzionale</p>	
<p>718 x 421 x H 15 cm 4,55 m³</p>	<p>522 x 372 x H 15 cm 2,91 m³</p>
200 x 80 x 78 cm - 285 kg	200 x 80 x 100 cm - 252 kg
405 x 111 x 54 cm - 1517 kg	405 x 111 x 40 cm - 1001 kg
<p> 8 4 12081 273266</p>	<p> 8 4 12081 318448  8 4 12081 319155</p>

wooden pools



790205 CARRA



790204 LEMON

REFERENCIA · REFERENCE ·
RÉFÉRENCE · RIFERIMENTO



EXTERIORES · OUTSIDE ·
EXTÉRIEURES · ESTERNO



INTERIORES · INSIDE ·
INTÉRIEURES · INTERNI



VOLUMEN DE AGUA · WATER VOLUME ·
VOLUME D'EAU · VOLUME DI ACQUA



LÍNEA DE AGUA · WATER LINE ·
LIGNE D'EAU · LINEA DELL'ACQUA



ESPEJOR MADERA · WOOD THICKNESS ·
ÉPAISSEUR MADRIER · DIMENSIONE



MACHIHEMBADO · TONGUE AND GROOVE ·
ASSEMBLAGE RAINURES LANGUETTES · INCASTRO



PLAYAS · EDGES · MARGELLES · BORDI



ANCHO · WIDTH · LARGEUR · LARGHEZZA

ESPEJOR · THICKNESS ·
ÉPAISSEUR · DIMENSIONE



EMBELLECEDORES METÁLICOS · METAL COVERS ·
CACHES ANGLES INOX · PROTEZIONE METALLICO



LINER



FILTRACIÓN · FILTRATION · FILTRO



PROTECTOR · PROTECTOR · FEUTRE · PROTEZIONE



FONDO · FLOOR · FOND



PARED · WALL · PAROI · PARETE



ESCALERA INTERIOR · INSIDE LADDER ·
ÉCHELLE INTÉRIEURE · SCALA INTERNA



ESCALERA EXTERIOR · OUTSIDE LADDER ·
ÉCHELLE EXTÉRIEURE · SCALA ESTERNA



ESTRUCTURA · STRUCTURE ·
STRUCTURE · STRUTTURA



TERRENO · TERRAIN · LAND · TERRENO



PALET 1 ACCESORIOS · ACCESSORIES ·
ACCESSOIRES · ACCESSORI



PALET 2 MADERA · WOOD · BOIS · LEGNO



CÓDIGO · EAN CODE ·
GENCOD · CODICE A BARRE

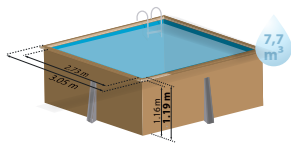



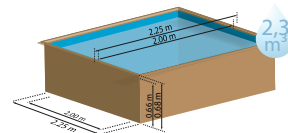





NEW
2024



CARRA 3

LEMON

CITY

WPCARR3 LDD: WPCARR3D	790204 LDD: 790204D	790000 LDD: 790000D
3,05 x 3,05 x H. 1,19 m	3,75 x 2,00 x H. 0,68 m	2,25 x 2,25 x H. 0,68 m
2,73 x 2,73 x H. 1,16 m	3,50 x 1,75 x H. 0,65 m	2,00 x 2,00 x H. 0,65 m
7,7 m ³	3,7 m ³	2,3 m ³
1,06 m	0,6 m	0,6 m
46 mm	36 mm	36 mm
14,5 cm	PANELES - BOARDS - PANNEAUX - PANNELLI	
Simple 19 cm 2,8 cm	Simple 19 cm 2,8 cm	Simple 14,5 cm 2,8 cm
60/100	50/100	50/100
FILTRO DE ARENA · SAND FILTER · FILTRATION À SABLE · FILTRO A SABBIA	FILTRO DE CARTUCHO · CARTRIDGE FILTER · EPURATEUR À CARTOUCHE · FILTRO A CARTUCCIA	
4 m ³ /h	2 m ³ /h	
Espesor · Thickness · Épaisseur · Dimensione: 200 g/m ²	Espesor · Thickness · Épaisseur · Dimensione: 100 g/m ²	
✓ ✓	✓	✓
ACERO INOXIDABLE · STAINLESS STEEL · ACIER INOXYDABLE · ACCIAIO INOX		
MADERA · WOOD · BOIS · LEGNO		
 CUÑA METÁLICA · WEDGE LE SABOT · CUNEO METALLICO	 OMEGA SYSTEM	
Losa de hormigón obligatoria · Obligatory concrete slab · Dalle béton Obligatoire · Basamento di calcestruzzo obbligatorio	Losa de hormigón opcional · Optional concrete slab · Dalle béton facultative · Basamento di calcestruzzo opzionale	
382 x 382 x H 15 cm 2,19 m ³	409 x 324 x H 15 cm 1,99 m ³	259 x 259 x H 10 0,67 m ³
120 x 80 x 78 cm - 160 kg	BOX: 60 x 40 x 80 cm - 40 kg	BOX: 47 x 30 x 70 cm - 15 kg
305 x 111 x 45 cm - 815 kg	180 x 65 x 59 cm - 351 kg	200 x 120 x 60 cm - 259 kg
 3 605217 902054  3 605217 902184	 3 605217 902047  3 605217 902177	 3 605217 900005  8 412081 003474

wooden pools



790203 AVOCADO



7900892 SAFRAN 2

REFERENCIA · REFERENCE ·
RÉFÉRENCE · RIFERIMENTO



EXTERIORES · OUTSIDE ·
EXTÉRIEURES · ESTERNO



INTERIORES · INSIDE ·
INTÉRIEURES · INTERNI



VOLUMEN DE AGUA · WATER VOLUME ·
VOLUME D'EAU · VOLUME DI ACQUA



LÍNEA DE AGUA · WATER LINE ·
LIGNE D'EAU · LINEA DELL'ACQUA



ESPESOR MADERA · WOOD THICKNESS ·
ÉPAISSEUR MADRIER · DIMENSIONE



MACHIHEMBADO · TONGUE AND GROOVE ·
ASSEMBLAGE RAINURES LANGUETTES · INCASTRO

PLAYAS · EDGES · MARGELLES · BORDI



ANCHO · WIDTH · LARGEUR · LARGHEZZA

ESPESOR · THICKNESS ·
ÉPAISSEUR · DIMENSIONE



EMBELLECEDORES METÁLICOS · METAL COVERS ·
CACHES ANGLES INOX · PROTEZIONE METALLICO



LINER



FILTRACIÓN · FILTRATION · FILTRO



PROTECTOR · PROTECTOR · FEUTRE · PROTEZIONE

FONDO · FLOOR · FOND



PARED · WALL · PAROI · PARETE



ESCALERA INTERIOR · INSIDE LADDER ·
ÉCHELLE INTÉRIEURE · SCALA INTERNA



ESCALERA EXTERIOR · OUTSIDE LADDER ·
ÉCHELLE EXTÉRIEURE · SCALA ESTERNA



ESTRUCTURA · STRUCTURE ·
STRUCTURE · STRUTTURA



TERRENO · TERRAIN · LAND · TERRENO



PALET 1 ACCESORIOS · ACCESSORIES ·
ACCESSOIRES · ACCESSORI



PALET 2 MADERA · WOOD · BOIS · LEGNO



CÓDIGO · EAN CODE ·
GENCOD · CODICE A BARRE

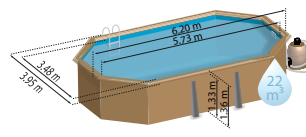
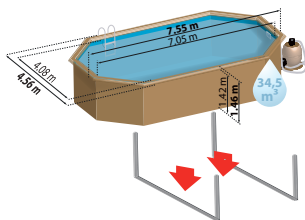

ORANGE

VERMELA

AVOCADO

SAFRAN 2

800007 LDD: 800007D	790098 LDD: 790098D	790203 LDD: 790203D	7900892 LDD: 7900892D
7,55 x 4,56 x H. 1,46 m	6,72 x 4,72 x 1,46 m	6,56 x 4,56 x H. 1,31 m	6,20 x 3,95 x H. 1,36 m
7,05 x 4,08 x H. 1,42 m	6,23 x 4,23 x 1,42 m	6,08 x 4,08 x H. 1,27 m	5,73 x 3,48 x H. 1,33 m
34,5 m ³	31 m ³	24,7 m ³	22 m ³
1,36 m	1,36 m	1,17 m	1,23 m
46 mm	46 mm	46 mm	46 mm
19 cm	14,5 cm	19 cm	19 cm
Double 14,5 cm x 2 = 29 cm	Double 14,5 cm x 2 = 29 cm	Double 14,5 cm x 2 = 29 cm	Double 14,5 cm x 2 = 29 cm
2,8 cm	2,8 cm	2,8 cm	2,8 cm
✓	✓	✓	✓
75/100	75/100	75/100	75/100
FILTRO DE ARENA · SAND FILTER · FILTRATION À SABLE · FILTRO A SABBIA			
10 m ³ /h	8 m ³ /h	8 m ³ /h	8 m ³ /h
Espesor · Thickness · Épaisseur · Dimensione: 200 g/m ²			
✓	✓	✓	✓
✓	✓	✓	✓
ACERO INOXIDABLE · STAINLESS STEEL · ACIER INOXYDABLE · ACCIAIO INOX			
MADERA · WOOD · BOIS · LEGNO			
IPE SYSTEM	CUÑA METÁLICA · WEDGE · SABOT · CUNEO METALLICO		
Losas de hormigón obligatoria · Obligatory concrete slab · Dalle béton Obligatoire · Basamento di calcestruzzo obbligatorio			
764 x 497 x H 17 cm 6,46 m ³	682 x 512 x H 17 cm 5,94 m ³	666 x 486 x H 15 4,87 m ³	632 x 457 x H 17 cm 4,33 m ³
200 x 80 x 100 cm - 410 kg	200 x 80 x 100 cm - 357 kg	200 x 80 x 100 cm - 250 kg	120 x 80 x 100 cm - 270 kg
405 x 102 x 75 cm - 1799 kg	405 x 111 x 59 cm - 1760 kg	400 x 114 x 65 cm - 1537 kg	405 x 111 x 57 cm - 1463 kg
8 4 12081 3 133 13 8 4 12081 3 144 57	3 605217 900982 8 4 12081 003498	3 605217 902030 3 605217 902146	8 4 12081 3 184 55 8 4 12081 3 191 48

wooden pools



REFERENCIA · REFERENCE ·
RÉFÉRENCE · RIFERIMENTO



EXTERIORES · OUTSIDE ·
EXTÉRIEURES · ESTERNO



INTERIORES · INSIDE ·
INTÉRIEURES · INTERNI



VOLUMEN DE AGUA · WATER VOLUME ·
VOLUME D'EAU · VOLUME DI ACQUA



LÍNEA DE AGUA · WATER LINE ·
LIGNE D'EAU · LINEA DELL'ACQUA



ESPESOR MADERA · WOOD THICKNESS ·
ÉPAISSEUR MADRIER · DIMENSIONE



MACHIHEMBRADO · TONGUE AND GROOVE ·
ASSEMBLAGE RAINURES LANGUETTES · INCASTRO

PLAYAS · EDGES · MARGELLES · BORDI



ANCHO · WIDTH · LARGEUR · LARGHEZZA

ESPESOR · THICKNESS ·
ÉPAISSEUR · DIMENSIONE



EMBELLECEDORES METÁLICOS · METAL COVERS ·
CACHES ANGLES INOX · PROTEZIONE METALLICO



LINER



FILTRACIÓN · FILTRATION · FILTRO



PROTECTOR · PROTECTOR · FEUTRE · PROTEZIONE



FONDO · FLOOR · FOND



PARED · WALL · PAROI · PARETE



ESCALERA INTERIOR · INSIDE LADDER ·
ÉCHELLE INTÉRIEURE · SCALA INTERNA



ESCALERA EXTERIOR · OUTSIDE LADDER ·
ÉCHELLE EXTÉRIEURE · SCALA ESTERNA



ESTRUCTURA · STRUCTURE ·
STRUCTURE · STRUTTURA



TERRENO · TERRAIN · LAND · TERRENO



PALET 1 ACCESORIOS · ACCESSORIES ·
ACCESSOIRES · ACCESSORI



PALET 2 MADERA · WOOD · BOIS · LEGNO



CÓDIGO · EAN CODE ·
GENCOD · CODICE A BARRE

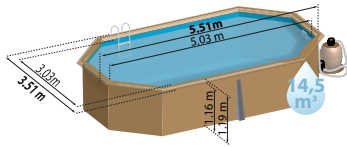

CANELLE

790087

LDD: 790087D

5,51 x 3,51 x H. 1,19 m

5,03 x 3,03 x H. 1,16 m

14,5 m³

1,09 m

46 mm

✓
14,5 cm

Double
14,5 cm x 2 = 29 cm

2,8 cm

✓

60/100

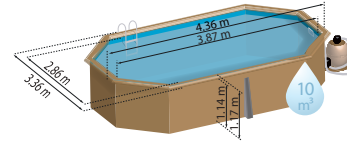

GRENADE 2

7900862

LDD: 7900862D

4,36 x 3,36 x H. 1,17 m

3,87 x 2,86 x H. 1,14 m

10 m³

1,07 m

46 mm

-
19 cm

Double
14,5 cm x 2 = 29 cm

2,8 cm

✓

60/100

FILTRO DE ARENA · SAND FILTER · FILTRATION À SABLE · FILTRO A SABBIA

6 m³/h

4 m³/h

Espeor · Thickness · Épaisseur · Dimensione: 200 g/m²

✓

✓

✓

✓

ACERO INOXIDABLE · STAINLESS STEEL · ACIER INOXYDABLE · ACCIAIO INOX

MADERA · WOOD · BOIS · LEGNO



CUÑA METÁLICA · WEDGE · SABOT · CUNEO METALLICO

Losa de hormigón obligatoria · Obligatory concrete slab · Dalle béton Obligatoire · Basamento di calcestruzzo obbligatorio

553 x 403 x H 15 cm
3,34 m³

446 x 395 x H 15 cm
2,64 m³

130 x 80 x 78 cm - 138 kg

120 x 80 x 78 cm - 140 kg

400 x 114 x 65 cm - 1078 kg

400 x 120 x 57 cm - 959 kg



wooden pools



KPBOC535 BAMBU



KPBOC632 MACADAMIA

	REFERENCIA · REFERENCE · RÉFÉRENCE · RIFERIMENTO
	EXTERIORES · OUTSIDE · EXTÉRIEURES · ESTERNO
	INTERIORES · INSIDE · INTÉRIEURES · INTERNI
	VOLUMEN DE AGUA · WATER VOLUME · VOLUME D'EAU · VOLUME DI ACQUA
	LÍNEA DE AGUA · WATER LINE · LIGNE D'EAU · LINEA DELL'ACQUA
	ESPEJOR MADERA · WOOD THICKNESS · ÉPAISSEUR MADRIER · DIMENSIONE
	MACHIHEMBRADO · TONGUE AND GROOVE · ASSEMBLAGE RAINURES LANGUETTES · INCASTRO
	PLAYAS · EDGES · MARGELLES · BORDI
	ANCHO · WIDTH · LARGEUR · LARGHEZZA
	ESPEJOR · THICKNESS · ÉPAISSEUR · DIMENSIONE
	EMBELLECEDORES METÁLICOS · METAL COVERS · CACHES ANGLES INOX · PROTEZIONE METALLICO
	LINER
	FILTRACIÓN · FILTRATION · FILTRO
	PROTECTOR · PROTECTOR · FEUTRE · PROTEZIONE
	FONDO · FLOOR · FOND
	PARED · WALL · PAROI · PARETE
	ESCALERA INTERIOR · INSIDE LADDER · ÉCHELLE INTÉRIEURE · SCALA INTERNA
	ESCALERA EXTERIOR · OUTSIDE LADDER · ÉCHELLE EXTÉRIEURE · SCALA ESTERNA
	ESTRUCTURA · STRUCTURE · STRUCTURE · STRUTTURA
	TERRENO · TERRAIN · LAND · TERRENO
	PALET 1 ACCESORIOS · ACCESSORIES · ACCESSOIRES · ACCESSORI
	PALET 2 MADERA · WOOD · BOIS · LEGNO
	CÓDIGO · EAN CODE · GENCOD · CODICE A BARRE

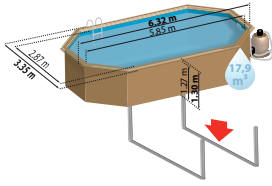

MACADAMIA

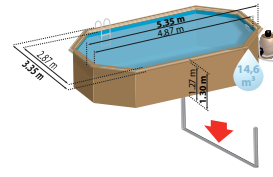

BAMBU

KPB0C632	KPB0C535
6,32 x 3,35 x H. 1,30 m	5,35 x 3,35 x H. 1,30 m
5,85 x 2,87 x H. 1,27 m	4,87 x 2,87x H. 1,27 m
17,9 m ³	14,6 m ³
1,17 m	1,17 m
46 mm	46 mm
✓ 14,5 cm	✓ 14,5 cm
Double 14,5 cm x 2 = 29 cm 2,8 cm	Double 14,5 cm x 2 = 29 cm 2,8 cm
✓	✓
60/100	60/100
FILTRO DE ARENA · SAND FILTER · FILTRATION À SABLE · FILTRO A SABBIA	
6 m ³ /h	6 m ³ /h
Espesor · Thickness · Épaisseur · Dimensione: 200 g/m ²	
✓ ✓	✓ ✓
ACERO INOXIDABLE · STAINLESS STEEL · ACIER INOXYDABLE · ACCIAIO INOX	
MADERA · WOOD · BOIS · LEGNO	
 SISTEMA DE OMEGAS · OMEGA SYSTEM · RENFORTS ENTERRÉS · SISTEMA OMEGA	
Losa de hormigón opcional · Optional concrete slab · Dalle béton facultative · Basamento di calcestruzzo opzionale	
642 x 435 x H 15 cm 4,20 m ³	545 x 435 x H 15 cm 3,56 m ³
200 x 80 x 78 cm - 250 kg	120 x 80 x 78 cm - 167 kg
405 x 111 x 54 cm - 1416 kg	355 x 111 x 53 cm - 1214 kg
 8 4 12081 273242	 8 4 12081 273235

wooden pools



790210 ANANAS



800003 VIOLETTE 2

REFERENCIA · REFERENCE ·
RÉFÉRENCE · RIFERIMENTO



EXTERIORES · OUTSIDE ·
EXTÉRIEURES · ESTERNO



INTERIORES · INSIDE ·
INTÉRIEURES · INTERNI



VOLUMEN DE AGUA · WATER VOLUME ·
VOLUME D'EAU · VOLUME DI ACQUA



LÍNEA DE AGUA · WATER LINE ·
LIGNE D'EAU · LINEA DELL'ACQUA



ESPESOR MADERA · WOOD THICKNESS ·
ÉPAISSEUR MADRIER · DIMENSIONE



MACHIHEMBRADO · TONGUE AND GROOVE ·
ASSEMBLAGE RAINURES LANGUETTES · INCASTRO

PLAYAS · EDGES · MARGELLES · BORDI



ANCHO · WIDTH · LARGEUR · LARGHEZZA

ESPESOR · THICKNESS ·
ÉPAISSEUR · DIMENSIONE



EMBELLECEDORES METÁLICOS · METAL COVERS ·
CACHES ANGLES INOX · PROTEZIONE METALLICO



LINER



FILTRACIÓN · FILTRATION · FILTRO



PROTECTOR · PROTECTOR · FEUTRE · PROTEZIONE



FONDO · FLOOR · FOND



PARED · WALL · PAROI · PARETE



ESCALERA INTERIOR · INSIDE LADDER ·
ÉCHELLE INTÉRIEURE · SCALA INTERNA



ESCALERA EXTERIOR · OUTSIDE LADDER ·
ÉCHELLE EXTÉRIEURE · SCALA ESTERNA



ESTRUCTURA · STRUCTURE ·
STRUCTURE · STRUTTURA



TERRENO · TERRAIN · LAND · TERRENO



PALET 1 ACCESORIOS · ACCESSORIES ·
ACCESSOIRES · ACCESSORI



PALET 2 MADERA · WOOD · BOIS · LEGNO



CÓDIGO · EAN CODE ·
GENCOD · CODICE A BARRE

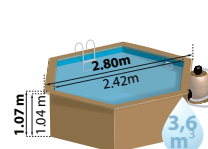
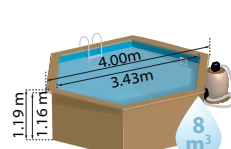
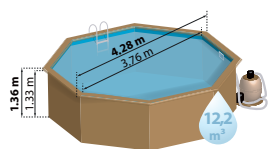
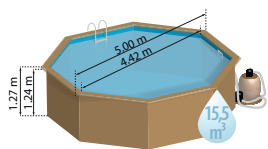

VIOLETTE 2

VASTO

ANANAS

VANILLE 2

LILI 2

800003 LDD: 800003D	790302 LDD: 790302D	790210 LDD: 790210D	800002 LDD: 800002D	800008 LDD: 800008D
Ø 5,00 x H. 1,27 m	Ø 4,28 x H. 1,36 m	Ø 4,28 x H. 1,17 m	Ø 4,00 x H. 1,19 m	Ø 2,80 x H. 1,07 m
Ø 4,42 x H. 1,24 m	Ø 3,76 x H. 1,33 m	Ø 3,76 x H. 1,14 m	Ø 3,43 x H. 1,16 m	Ø 2,42 x H. 1,04 m
15,5 m ³	12,2 m ³	10,5 m ³	8 m ³	3,6 m ³
1,17 m	1,23 m	1,07 m	1,09 m	0,97 m
46 mm	46 mm	46 mm	46 mm	46 mm
19 cm	19 cm	19 cm	19 cm	19 cm
Double 14,5 cm x 2 = 29 cm 2,8 cm	Double 14,5 cm x 2 = 29 cm 2,8 cm	Double 14,5 cm x 2 = 29 cm 2,8 cm	Double 14,5 cm x 2 = 29 cm 2,8 cm	Simple 19 cm 2,8 cm
✓	✓	✓	✓	
75/100	75/100	75/100	50/100	50/100
FILTRO DE ARENA · SAND FILTER · FILTRATION À SABLE · FILTRO A SABBIA				AQUALOON
6 m ³ /h	4 m ³ /h	6 m ³ /h	4 m ³ /h	4 m ³ /h
Espesor · Thickness · Épaisseur · Dimensione: 200 g/m ²				
✓	✓	✓	✓	100 g/m ²
✓	✓	✓	✓	
ACERO INOXIDABLE · STAINLESS STEEL · ACIER INOXYDABLE · ACCIAIO INOX				Escala seguridad plataforma Safety ladder platform Échelle sécurité plateforme Scala di sicurezza piattaforma
MADERA · WOOD · BOIS · LEGNO				
Losas de hormigón opcional · Optional concrete slab · Dalle béton facultative · Basamento di calcestruzzo opzionale				
467 x 467 x H 10 cm 2,18 m ³	406 x 406 x H 10 cm 1,64 m ³	407 x 407 x H 10 cm 1,65 m ³	356 x 356 x H 10 cm 1,27 m ³	268 x 268 x H 10 cm 0,72 m ³
120 x 80 x 78 cm - 120 kg	120 x 80 x 78 cm - 105 kg	120 x 80 x 78 cm - 115 kg	120 x 80 x 78 cm - 95 kg	120 x 80 x 78 cm - 54 kg
205 x 111 x 76 cm - 1086 kg	180 x 105 x 75 cm - 1021kg	180 x 105 x 75 cm - 936 kg	205 x 111 x 59 cm - 784 kg	155 x 102 x 55 cm - 508kg

deck



DECKVASTO



DECKSAFRAN2



DECK1



VASTO - 790302

SAFRAN 2 - 7900892



Ø 4,28 x H. 1,36 m

6,20 x 3,95 x H. 1,36 m



Ø 3,76 x H. 1,33 m

5,73 x 3,48 x H. 1,33 m



Losa de hormigón **opcional**
Optional concrete slab
Dalle béton **facultative**
Basamento di calcestruzzo **opzionale**

Losa de hormigón **obligatoria**
Obligatory concrete slab
Dalle béton **obligatoire**
Basamento di calcestruzzo **obbligatorio**



535 x 456 x H 10 cm
2,44 m³

760 x 496 x H 17 cm
6,40 m³

- Para piscinas:
 - For pools:
 - Pour piscines:
 - Per piscine:
- VASTO
SAFRAN2

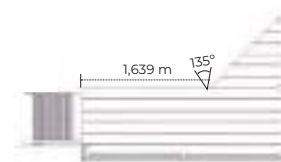

H. 1,36 m



8 4 12081 318493



8 4 12081 318486



8 4 12081 318509

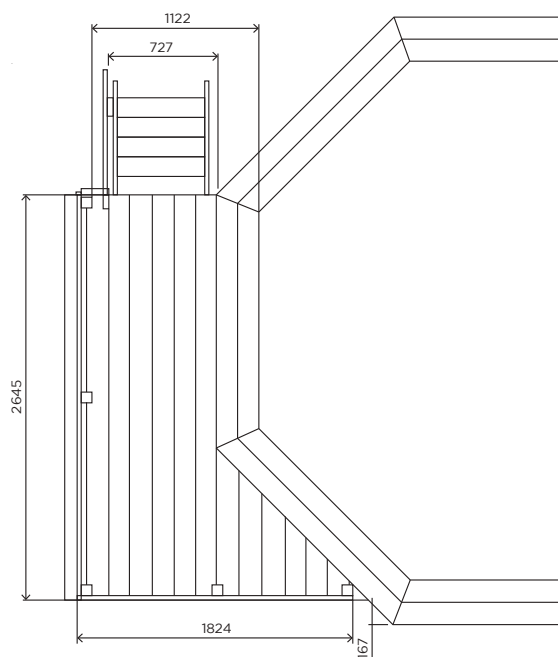

DECK

- **USO:** Almacena tu equipo de filtración o cualquier otro elemento.
- **USE:** Store your filtration equipment or any other item
- **UTILISATION:** Abrite votre système de filtration ou tout autre équipement d'entretien de votre piscine.
- **UTILIZZO:** Conserva la tua attrezzatura di filtrazione o qualsiasi altro oggetto.



Avantgarde

POOLS

composite pools



■ PISCINAS DE COMPOSITE

LINER: tratamiento Anti-ultravioleta que retrasa el envejecimiento del P.V.C

COMPOSITE: las piscinas de composite están fabricadas de un nuevo material mezcla de madera (harina de madera) y polímeros.

■ PISCINES COMPOSITE

LINER : traitement anti-ultraviolets contre le vieillissement du P.V.C.

COMPOSITE : les piscines "composite" sont fabriquées avec un nouveau matériau composé d'un mélange de bois (farine de bois) et de polymères.

■ COMPOSITE POOLS

LINER: anti-ultraviolet treatment to slow down P.V.C aging.

COMPOSITE: composite pools are made of a new material composed of wood (wood flour) and polymers.

■ PISCINA IN COMPOSITE

LINER: Trattamento Anti-ultravioletti - Ritarda l'invecchiamento del P.V.C.

COMPOSITE: Le piscine in composite vengono prodotte con un nuovo materiale composto da una miscela di legno (farina di legno) e polimeri.



Resina plástica
Plastic resin
Résine plastique
Resina plastica

+



Serrín
Sawdust
Farine de bois
Segatura

+



Pigmento
Pigments
Pigments
Pigmenti

+



Aditivos con carga mineral
Mineral additives
Additifs Charge minérale
Additivi con carica minerale

=



■ REFUERZOS DE ESTRUCTURA ■ STRUCTURAL REINFORCEMENTS ■ RENFORTS DE STRUCTURE ■ RINFORZI STRUTTURALI

■ VIGAS METÁLICAS (SISTEMA IPE) ■ BURIED STEEL BEAMS (IPE SYSTEM) ■ BERCEAUX (IPE) ■ BARRA DI ACCIAIO (SISTEMA IPE)

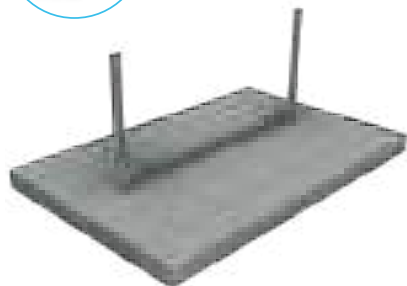
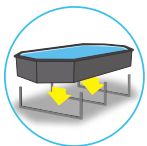

■ Las vigas metálicas se encastran en la losa de hormigón, con un espesor mínimo de 17 cm). Su colocación forma parte del proceso de montaje de la estructura (consultar el manual de instalación).

■ Buried steel beams are embedded in the concrete slab, with a minimum thickness of 17 cm. Their installation is part of the structure assembly process (check installation warning)

■ Les berceaux métalliques sont à noyer dans la dalle béton, épaisseur minimum de 17 cm). Leur pose fait partie intégrante du montage de la structure (cf. notice de montage).

■ La barra di acciaio vengono incassate nella lastra di calcestruzzo, con uno spessore minimo di 17cm. Il loro posizionamento fa parte del processo di assemblaggio della struttura (vedere indicazioni per il montaggio).



■ Losa de hormigón obligatoria ■ Concrete slab is mandatory ■ Dalle béton obligatoire ■ Lastra di calcestruzzo obbligatorio



■ CUÑA METÁLICA ■ METALLIC WEDGE ■ SABOTS ■ CUNEO METALLICO



■ Es obligatorio realizar una losa de hormigón, de 15 cm de espesor mínimo, previamente al montaje de la piscina para fijar las cuñas metálicas. Antes de montar la piscina, consultar el manual de instalación y el video de montaje.

■ The wedge is fixed over the concrete slab. In such a way, it is mandatory to make the slab, of 15 cm minimum, beforehand to the assembly of the pool. Before assembling pool, check installation warning and assembly video.

■ Le sabot vient se fixer sur la dalle en béton. Il est donc impératif de réaliser une dalle de 15 cm minimum avant le montage du bassin. Préalablement au montage du bassin cf. notice de montage et vidéo de montage.

■ Il cuneo metallico si fissa sopra il massetto di cemento. Quindi è obbligatorio realizzare il massetto dello spessore minimo di 15 cm prima del montaggio della piscina. Prima di montare la vasca consultare le indicazioni e il video di montaggio.



■ Losa de hormigón obligatoria ■ Concrete slab is mandatory ■ Dalle béton obligatoire ■ Lastra di calcestruzzo obbligatorio



■ SISTEMA DE OMEGAS ■ OMEGA SYSTEM ■ RENFORTS ENTERRÉS ■ SISTEMA OMEGA

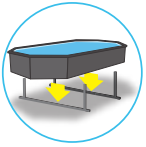

- Viga de acero enterrada de 15x15 cm que hace innecesarios los postes exteriores, obteniendo mejor aprovechamiento del jardín.
- 15x15 cm buried steel beam makes unnecessary the outer buttress, optimizing the use of the garden area.
- Poteaux en acier à enterrer de 15x15 cm évitant des renforts apparents extérieurs, pour mieux profiter de l'espace du jardin.
- Barra di acciaio interrata da 15x15 cm che non rende necessario l'utilizzo delle barre laterali; permette di poter sfruttare al meglio gli spazi del proprio giardino.



- Losa de hormigón opcional ■ Concrete slab is optional ■ Dalle béton facultative ■ Lastra di calcestruzzo opzionale



composite pool

serie AVANTGARDE



KPCOR60

	KPCOR60LN	KPCOR60N	KPCOR46N
	606x326 cm	606x326 cm	466x326 cm
	560x280 cm	560x280 cm	420x280 cm
	124 cm	124 cm	124 cm
	17,87 m ³	17,87 m ³	13,40 m ³
	1224 kg	1220 kg	1000 kg
	6 m ³ /h	6 m ³ /h	6 m ³ /h
	✓	✓	✓
	✓	✓	✓
	✓	-	-
	IPE SYSTEM		
	Losa de hormigón obligatoria · Obligatory concrete slab · Dalle béton Obligatoire · Basamento di calcestruzzo obbligatorio		
	700x420 cm	700x420 cm	560x420 cm
	1/170x130	1/170x130	1/170x130
	8 4 12081 307862	8 4 12081 307855	8 4 12081 307879

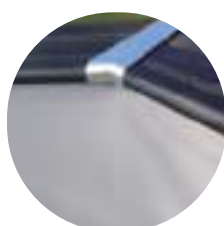

- Liner PVC gris 60/100
- PVC grey liner 60/100
- Liner PVC gris 60/100
- Liner PVC grigio 60/100



- Embellecedores y perfilera de aluminio
- Aluminium profiles and trims
- Protections et margelles en aluminium
- Profili in alluminio



- Depuradora arena
- Sand filter
- Filtre à sable
- Filtro a sabbia





KPCOR28



KPCOR28

KPCOR2814

	326x326 cm	326x186 cm
	280x280 cm	280x140 cm
	96 cm	96 cm
	6,60 m ³	3,30 m ³
	900 kg	450 kg
	4 m ³ /h	4 m ³ /h
	✓	✓
	✓	✓
	-	-
	 CUÑA METÁLICA · WEDGE · SABOT · CUNEO METALLICO	
	Losa de hormigón obligatoria · Obligatory concrete slab · Dalle béton Obligatoire · Basamento di calcestruzzo obbligatorio	
	426x426 cm	426x268 cm
	1/170x130	1/170x130
	 8 4 12081 302683	 8 4 12081 304953



- Proyector led blanco
- White led projector
- Projecteur led blanc
- Proiettore a led bianco

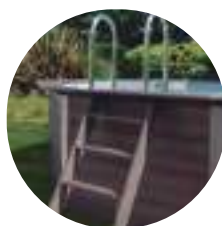

- Escalera: Composite / Inox
- Ladder: Composite / stainless steel
- Échelle: Composite / inox
- Scale: Composite / acciaio inox



- Manta protectora (Poliéster)
- Bottom protective blanket (Polyester)
- Tapis de sol en feutre (Polyester)
- Telo di protezione (Poliestere)

composite pool

serie AVANTGARDE



KPCOV52



	KPCOV6650	KPCOV80	KPCOV66L	KPCOV66	KPCOV52L	KPCOV52
	664x386 cm	804x386 cm	664x386 cm	664x386 cm	524x386 cm	524x386 cm
	618x338 cm	758x338 cm	618x338 cm	618x338 cm	478x338 cm	478x338 cm
	154 cm	124 cm	124 cm	124 cm	124 cm	124 cm
	27,5 m ³	27 m ³	21,5 m ³	21,5 m ³	16,2 m ³	16,2 m ³
	1600 kg	1450 kg	1220 kg	1220 kg	960 kg	960 kg
	8 m ³ /h	6 m ³ /h	6 m ³ /h	6 m ³ /h	6 m ³ /h	6 m ³ /h
	✓	✓	✓	✓	✓	✓
	✓	✓	✓	✓	✓	✓
	-	-	✓	-	✓	-
	IPE SYSTEM*	SISTEMA DE OMEGAS · OMEGA SYSTEM · RENFORTS ENTERRÉS · SISTEMA OMEGA				
		Losa de hormigón opcional · Optional concrete slab Dalle béton facultative · Basamento di calcestruzzo opzionale				
	704x506 cm	844x506 cm	704x506 cm	704x506 cm	564x506 cm	564x506 cm
	1/170x150	1/170x150	1/170x150	1/170x150	1/170x130	1/170x130

8 412081 312705 8 412081 268804 8 412081 313108 8 412081 268798 8 412081 318608 8 412081 268781

* Es obligatorio enterrar la piscina un mínimo de una lama (30cm) · It is compulsory to bury the pool a minimum of one slat (30 cm) · Il est obligatoire d'enterrer la piscine d'au moins une latte (30cm) · È obbligatorio interrare la piscina per un minimo di una doga (30 cm)

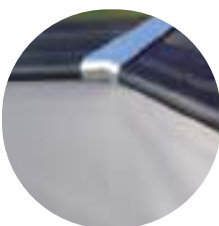

- Liner PVC gris 60/100
- PVC grey liner 60/100
- Liner PVC gris 60/100
- Liner PVC grigio 60/100



- Embellecedores y periferia de aluminio
- Aluminium profiles and trims
- Protections et margelles en aluminium
- Profili in alluminio



- Depuradora arena
- Sand filter
- Filtre à sable
- Filtro a sabbia



KPCO41



KPCO41

	ø 410 cm
	ø 360 cm
	124 cm
	11 m ³
	705 kg
	4 m ³ /h
	✓
	✓
	-
Losa de hormigón opcional · Optional concrete slab Dalle béton facultative · Basamento di calcestruzzo opzionale	
	450x450 cm
	1/170x130
	8 4 12081 268774



- Proyector led blanco
- White led projector
- Projecteur led blanc
- Proiettore a led bianco

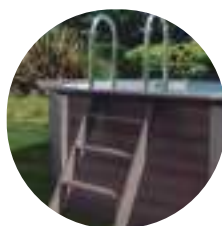

- Escalera: Composite / Inox
- Ladder: Composite / stainless steel
- Échelle: Composite / inox
- Scale: Composite / acciaio inox

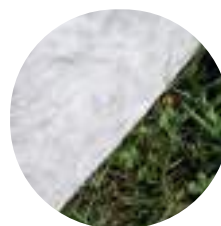

- Manta protectora (Poliéster)
- Bottom protective blanket (Polyester)
- Tapis de sol en feutre (Polyester)
- Telo di protezione (Poliestere)



dream pool



■ PISCINA DE PARED DE ACERO

LINER: tratamiento Anti - Ultravioleta que retrasa el envejecimiento del P.V.C.

CHAPA: laminada en frío con tratamiento de galvanización, fosfatación, imprimación y lacado. Perfilación vertical de la misma para la obtención de una mayor resistencia. Troquelada para skimmer y válvula de retorno del agua.

PIEZAS ESTRUCTURALES: de acero.

■ STEEL WALL POOL

LINER: anti-ultraviolet treatment to slow down P.V.C aging.

PLATE: galvanized, phosphatized, primed and lacquered cold-rolled plate. Vertical sectioning for an increased strength. Die cut for skimmer and water return valve openings.

STRUCTURAL PARTS: steel

■ PISCINES HORS SOL AVEC PAROIS EN ACIER

LINER : traitement anti-ultraviolets contre le vieillissement du P.V.C.

TÔLE: tôle laminée à froid et traitée par galvanisation, phosphatage, couche d'apprêt et laquage. Profils verticaux pour une meilleure résistance. Découpage pour le skimmer et la buse de refoulement.

PIÈCES STRUCTURELLES : métalliques

■ PISCINE CON PARETI IN ACCIAIO

LINER: Trattamento Anti-ultravioletti - Ritarda l'invecchiamento del P.V.C.

PANNELLO: Laminata a freddo con trattamento di galvanizzazione, fosfatazione e preparazione. Preparazione verticale per ottenere una maggiore resistenza. Stampigliatura per Skimmer e valvola di ritorno dell'acqua.

PEZZI STRUTTURALI: Acciaio.



dream pool







serie **ISLANDIA**



KITPROV7388N

KITPROV7388N

KITPROV6188N

	730x375 cm	610x375 cm
	132 cm	132 cm
	28,21 m ³	23,28 m ³
	348 kg	279 kg
	1/120x80	1/90x80
	6 m ³ /h	6 m ³ /h
	✓	✓
	✓	✓
	770x495 cm	650x495 cm



8 412081 313665



8 412081 313672



- Liner PVC gris 40/100
- PVC grey liner 40/100
- Liner PVC gris 40/100
- Liner PVC grigio 40/100



- Protectores de inyección
- Injection savers
- Protections moulées par injection
- Angolare di protezione

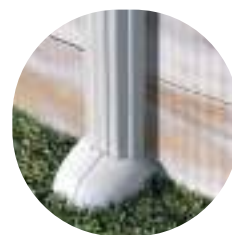

- Perfilería de acero
- Bottom cover
- Poteaux et margelles acier
- Profili in acciaio



■ Sistema de omegas

Viga de acero enterrada de 15x15 cm que hace innecesarios los postes exteriores, obteniendo mejor aprovechamiento del jardín.

■ Omega system

15x15 cm buried steel beam makes unnecessary the outer buttress, optimizing the use of the garden area.

■ Renforts enterrés

Poteaux en acier à enterrer de 15x15 cm évitant des renforts apparents extérieurs, pour mieux profiter de l'espace du jardin.

■ Sistema omega

Barra di acciaio interrata da 15x15 cm che non rende necessario l'utilizzo delle barre laterali; permette di poter sfruttare al meglio gli spazi del proprio giardino.



- Depuradora arena
- Sand filter
- Filtre à sable
- Filtro a sabbia



- Escalera de seguridad
- Safety ladder
- Échelle sécurité
- Scala di sicurezza



- Tapiz protector
- Floor tapestry
- Tapis de sol en feutre
- Telo di protezione

dream pool

serie **GROENLANDIA**



KITPROV738N

	KITPROV738N	KITPROV618N	KITPROV508N
	730x375 cm	610x375 cm	500x300 cm
	132 cm	132 cm	132 cm
	28,21 m ³	23,28 m ³	16,21 m ³
	335 kg	270 kg	260 kg
	1/120x80	1/90x80	1/90x80
	6 m ³ /h	6 m ³ /h	6 m ³ /h
	✓	✓	✓
	✓	✓	✓
	770x595 cm	650x595 cm	540x520 cm
	8 412081 313689	8 412081 313696	8 412081 313719



- Liner PVC gris 40/100
- PVC grey liner 40/100
- Liner PVC gris 40/100
- Liner PVC grigio 40/100



- Protectores de inyección
- Injection savers
- Protections moulées par injection
- Angolare di protezione



- Periferia de acero
- Bottom cover
- Poteaux et margelles acier
- Profili in acciaio



KITPR558N



	KITPR558N	KITPR458N	KITPR358N
	Ø550 cm	Ø460 cm	Ø350 cm
	132 cm	132 cm	132 cm
	27,79 m ³	19,44 m ³	11,25 m ³
	243 kg	238 kg	184 kg
	1/90x80	1/90x80	1/90x80
	6 m ³ /h	6 m ³ /h	6 m ³ /h
	✓	✓	✓
	✓	✓	✓
	600x600 cm	500x500 cm	400x400 cm
	8 4 1208 1 3 1370 2	8 4 1208 1 3 1372 6	8 4 1208 1 3 1373 3



- Depuradora arena
- Sand filter
- Filtre à sable
- Filtro a sabbia



- Escalera de seguridad
- Safety ladder
- Échelle sécurité
- Scala di sicurezza



- Tapiz protector
- Floor tapestry
- Tapis de sol en feutre
- Telo di protezione

dream pool

serie **FINLANDIA**

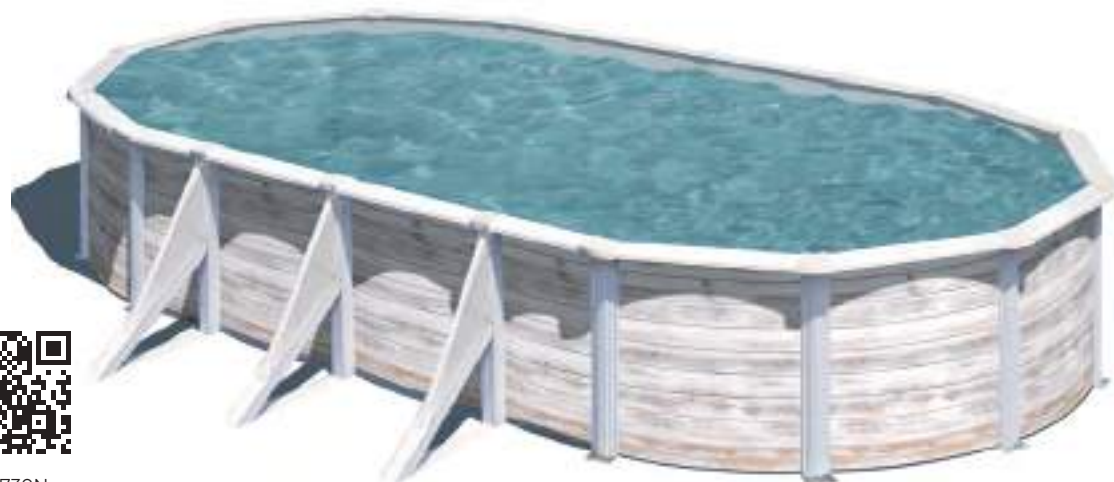

KIT730N

	KIT730N	KIT610N	KIT500N
	730x375 cm	610x375 cm	500x300 cm
	120 cm	120 cm	120 cm
	25,32 m ³	20,89 m ³	14,55 m ³
	287 kg	235 kg	224 kg
	1/90x80	1/80x60	1/80x60
	4 m ³ /h	4 m ³ /h	4 m ³ /h
	✓	✓	✓
	770x595 cm	650x595 cm	540x520 cm
	 8 412081 313740	 8 412081 313757	 8 412081 313764



- Liner PVC gris 30/100
 - PVC grey liner 30/100
 - Liner PVC gris 30/100
 - Liner PVC grigio 30/100
- KIT730/610N: 40/100



- Protectores de inyección
- Injection savers
- Protections moulées par injection
- Angolare di protezione

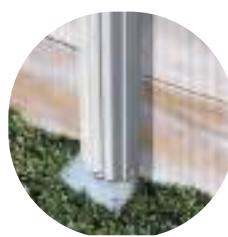

- Perfilera de acero
- Bottom cover
- Poteaux et margelles acier
- Profili in acciaio



KIT460N



	KIT460N	KIT350N	KIT300N	KIT240N
	Ø460 cm	Ø350 cm	Ø300 cm	Ø240 cm
	120 cm	120 cm	120 cm	120 cm
	17,45 m ³	10,10 m ³	7,41 m ³	4,75 m ³
	172 kg	146 kg	136 kg	126 kg
	1/80x60	1/80x60	1/80x60	1/80x60
	4 m ³ /h	4 m ³ /h	4 m ³ /h	4 m ³ /h
	✓	✓	✓	✓
	500x500 cm	400x400 cm	350x350 cm	300x300 cm
	8 4 12081 313771	8 4 12081 313788	8 4 12081 313962	8 4 12081 313795



- Depuradora arena
- Sand filter
- Filtre à sable
- Filtro a sabbia



- Escalera de seguridad
- Safety ladder
- Échelle sécurité
- Scala di sicurezza

dream pool

serie **CAPRI**











KITPROV7388GF



KITPROV7388GF

KITPROV6188GF

	730x375 cm	610x375 cm
	132 cm	132 cm
	28,21 m ³	23,28 m ³
	348 kg	279 kg
	1/120x80	1/90x80
	6 m ³ /h	6 m ³ /h
	✓	✓
	✓	✓
	770x495 cm	650x495 cm



8 412081 272382

8 412081 272399

 Références non disponibles en France



- Liner PVC gris 40/100
- PVC grey liner 40/100
- Liner PVC gris 40/100
- Liner PVC grigio 40/100



- Protectores de inyección
- Injection savers
- Protections moulées par injection
- Angolare di protezione



- Periferia de acero
- Bottom cover
- Poteaux et margelles acier
- Profili in acciaio



■ Sistema de omegas

Viga de acero enterrada de 15x15 cm que hace innecesarios los postes exteriores, obteniendo mejor aprovechamiento del jardín.

■ Omega system

15x15 cm buried steel beam makes unnecessary the outer buttress, optimizing the use of the garden area.

■ Renforts enterrés

Poteaux en acier à enterrer de 15x15 cm évitant des renforts apparents extérieurs, pour mieux profiter de l'espace du jardin.

■ Sistema omega

Barra di acciaio interrata da 15x15 cm che non rende necessario l'utilizzo delle barre laterali; permette di poter sfruttare al meglio gli spazi del proprio giardino.



- Depuradora arena
- Sand filter
- Filtre à sable
- Filtro a sabbia



- Escalera de seguridad
- Safety ladder
- Échelle sécurité
- Scala di sicurezza



- Tapiz protector
- Floor tapestry
- Tapis de sol en feutre
- Telo di protezione

dream pool

serie **GRANADA**



KITPROV738GF

	KITPROV738GF	KITPROV618GF	KITPROV508GF
	730x375 cm	610x375 cm	500x300 cm
	132 cm	132 cm	132 cm
	28,21 m ³	23,28 m ³	16,21 m ³
	335 kg	270 kg	260 kg
	1/120x80	1/90x80	1/90x80
	6 m ³ /h	6 m ³ /h	6 m ³ /h
	✓	✓	✓
	✓	✓	✓
	770x595 cm	650x595 cm	540x520 cm
	8 412081 272405	8 412081 272412	8 412081 272429

Références non disponibles en France



- Liner PVC gris 40/100
- PVC grey liner 40/100
- Liner PVC gris 40/100
- Liner PVC grigio 40/100



- Protectores de inyección
- Injection savers
- Protections moulées par injection
- Angolare di protezione



- Periferia de acero
- Bottom cover
- Poteaux et margelles acier
- Profili in acciaio



KITPR558GF



KITPR558GF

KITPR458GF

KITPR358GF

	Ø550 cm	Ø460 cm	Ø350 cm
	132 cm	132 cm	132 cm
	27,79 m ³	19,44 m ³	11,25 m ³
	243 kg	238 kg	184 kg
	1/90x80	1/90x80	1/90x80
	6 m ³ /h	6 m ³ /h	6 m ³ /h
	✓	✓	✓
	✓	✓	✓
	600x600 cm	500x500 cm	400x400 cm



Références non disponibles en France



- Depuradora arena
- Sand filter
- Filtre à sable
- Filtro a sabbia



- Escalera de seguridad
- Safety ladder
- Échelle sécurité
- Scala di sicurezza



- Tapiz protector
- Floor tapestry
- Tapis de sol en feutre
- Telo di protezione

dream pool

serie **KEA**



KIT610GF

	KIT730GF	KIT610GF	KIT500GF
	730x375 cm	610x375 cm	500x300 cm
	120 cm	120 cm	120 cm
	25,32 m ³	20,89 m ³	14,55 m ³
	287 kg	235 kg	224 kg
	1/90x80	1/80x60	1/80x60
	4 m ³ /h	4 m ³ /h	4 m ³ /h
	✓	✓	✓
	770x595 cm	650x595 cm	540x520 cm
	 8 412081 272467	 8 412081 272474	 8 412081 273082

Références non disponibles en France



- Liner PVC gris 30/100
 - PVC grey liner 30/100
 - Liner PVC gris 30/100
 - Liner PVC grigio 30/100
- KIT730/610GF: 40/100

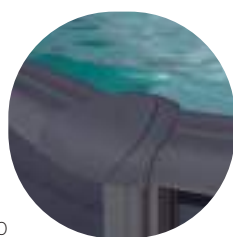

- Protectores de inyección
- Injection savers
- Protections moulées par injection
- Angolare di protezione



- Perifería de acero
- Bottom cover
- Poteaux et margelles acier
- Profili in acciaio



KIT350GF



	KIT460GF	KIT350GF	KIT300GF	KIT240GF
	Ø460 cm	Ø350 cm	Ø300 cm	Ø240 cm
	120 cm	120 cm	120 cm	120 cm
	17,45 m ³	10,10 m ³	7,41 m ³	4,75 m ³
	172 kg	146 kg	136 kg	126 kg
	1/80x60	1/80x60	1/80x60	1/80x60
	4 m ³ /h	4 m ³ /h	4 m ³ /h	4 m ³ /h
	✓	✓	✓	✓
	500x500 cm	400x400 cm	350x350 cm	300x300 cm
	8 4 12081 272498	8 4 12081 272504	8 4 12081 309071	8 4 12081 302720

Références non disponibles en France



- Depuradora arena
- Sand filter
- Filtre à sable
- Filtro a sabbia



- Escalera de seguridad
- Safety ladder
- Échelle sécurité
- Scala di sicurezza

dream pool



serie **AMAZONIA**



KITPROV7388WO

KITPROV7388WO

KITPROV6188WO

	730x375 cm	610x375 cm
	132 cm	132 cm
	28,21 m ³	23,28 m ³
	348 kg	279 kg
	1/120x80	1/90x80
	6 m ³ /h	6 m ³ /h
	✓	✓
	✓	✓
	770x495 cm	650x495 cm



8 412081 257334

8 412081 257341

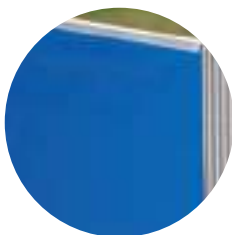

- Liner PVC azul 40/100
- PVC blue liner 40/100
- Liner PVC bleu 40/100
- Liner PVC blu 40/100

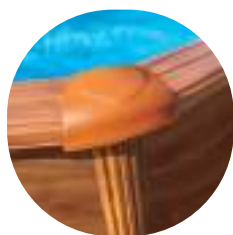

- Protectores de inyección
- Injection savers
- Protections moulées par injection
- Angolare di protezione

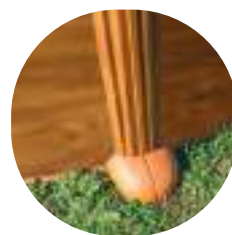

- Perfilera de acero
- Bottom cover
- Poteaux et margelles acier
- Profili in acciaio



■ **Sistema de omegas**

Viga de acero enterrada de 15x15 cm que hace innecesarios los postes exteriores, obteniendo mejor aprovechamiento del jardín.

■ **Omega system**

15x15 cm buried steel beam makes unnecessary the outer buttress, optimizing the use of the garden area.

■ **Renforts enterrés**

Poteaux en acier à enterrer de 15x15 cm évitant des renforts apparents extérieurs, pour mieux profiter de l'espace du jardin.

■ **Sistema omega**

Barra di acciaio interrata da 15x15 cm che non rende necessario l'utilizzo delle barre laterali; permette di poter sfruttare al meglio gli spazi del proprio giardino.



- Depuradora arena
- Sand filter
- Filtre à sable
- Filtro a sabbia



- Escalera de seguridad
- Safety ladder
- Échelle sécurité
- Scala di sicurezza



- Tapiz protector
- Floor tapestry
- Tapis de sol en feutre
- Telo di protezione

dream pool

serie **MAURITIUS**



KITPROV738WO

	KITPROV738WO	KITPROV618WO	KITPROV508WO
	730x375 cm	610x375 cm	500x300 cm
	132 cm	132 cm	132 cm
	28,21 m ³	23,28 m ³	16,21 m ³
	335 kg	270 kg	260 kg
	1/120x80	1/90x80	1/90x80
	6 m ³ /h	6 m ³ /h	6 m ³ /h
	✓	✓	✓
	✓	✓	✓
	770x595 cm	650x595 cm	540x520 cm
	8 412081 257358	8 412081 257365	8 412081 258089



- Liner PVC azul 40/100
- PVC blue liner 40/100
- Liner PVC bleu 40/100
- Liner PVC blu 40/100

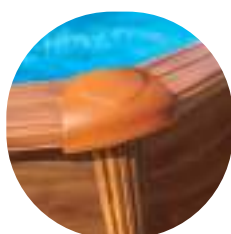

- Protectores de inyección
- Injection savers
- Protections moulées par injection
- Angolare di protezione



- Perfilería de acero
- Bottom cover
- Poteaux et margelles acier
- Profili in acciaio



KITPR558WO



KITPR558WO

KITPR458WO

KITPR358WO

	Ø550 cm	Ø460 cm	Ø350 cm
	132 cm	132 cm	132 cm
	27,79 m ³	19,44 m ³	11,25 m ³
	243 kg	238 kg	184 kg
	1/90x80	1/90x80	1/90x80
	6 m ³ /h	6 m ³ /h	6 m ³ /h
	✓	✓	✓
	✓	✓	✓
	600x600 cm	500x500 cm	400x400 cm
	 8 412081 257372	 8 412081 257389	 8 412081 257396



- Depuradora arena
- Sand filter
- Filtre à sable
- Filtro a sabbia



- Escalera de seguridad
- Safety ladder
- Échelle sécurité
- Scala di sicurezza



- Tapiz protector
- Floor tapestry
- Tapis de sol en feutre
- Telo di protezione

dream pool

serie **PACIFIC**



KIT730W

	KIT730W	KIT610W	KIT500W
	730x375 cm	610x375 cm	500x300 cm
	120 cm	120 cm	120 cm
	25,32 m ³	20,89 m ³	14,55 m ³
	287 kg	235 kg	224 kg
	1/90x80	1/80x60	1/80x60
	4 m ³ /h	4 m ³ /h	4 m ³ /h
	✓	✓	✓
	770x595 cm	650x595 cm	540x520 cm
	 8 412081 232249	 8 412081 225104	 8 412081 231068

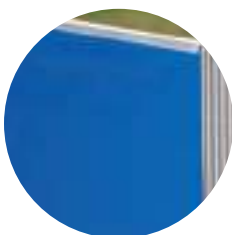

- Liner PVC azul 30/100
 - PVC blue liner 30/100
 - Liner PVC bleu 30/100
 - Liner PVC blu 30/100
- KIT730/610W: 40/100

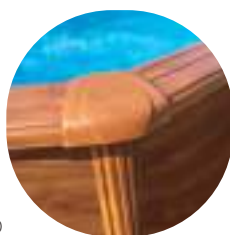

- Protectores de inyección
- Injection savers
- Protections moulées par injection
- Angolare di protezione



- Perfilería de acero
- Bottom cover
- Poteaux et margelles acier
- Profili in acciaio



KIT460W



	KIT460W	KIT350W	KIT300W	KIT240W
	Ø460 cm	Ø350 cm	Ø300 cm	Ø240 cm
	120 cm	120 cm	120 cm	120 cm
	17,45 m ³	10,10 m ³	7,41 m ³	4,75 m ³
	172 kg	146 kg	136 kg	126 kg
	1/80x60	1/80x60	1/80x60	1/80x60
	4 m ³ /h	4 m ³ /h	4 m ³ /h	4 m ³ /h
	✓	✓	✓	✓
	500x500 cm	400x400 cm	350x350 cm	300x300 cm
	8 4 12081 225111	8 4 12081 225722	8 4 12081 309095	8 4 12081 226163



- Depuradora arena
- Sand filter
- Filtre à sable
- Filtro a sabbia



- Escalera de seguridad
- Safety ladder
- Échelle sécurité
- Scala di sicurezza

dream pool

serie **SICILIA**



KITPROV503W

KITPROV503W

	500x300 cm
	120 cm
	14,55 m ³
	205 kg
	1/80x60
	3,8 m ³ /h
	✓
	540x520 cm



- Liner PVC azul 30/100
- PVC blue liner 30/100
- Liner PVC bleu 30/100
- Liner PVC blu 30/100

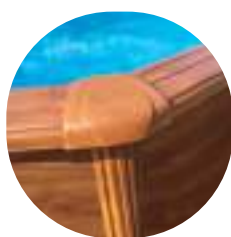

- Protectores de inyección
- Injection savers
- Protections moulées par injection
- Angolare di protezione



- Perfilaría de acero
- Bottom cover
- Poteaux et margelles acier
- Profili in acciaio



KITPR453W



KITPR453W

KITPR353W

KITPR303W

	Ø460 cm	Ø350 cm	Ø300 cm
	120 cm	120 cm	120 cm
	17,45 m ³	10,10 m ³	7,41 m ³
	149 kg	109 kg	94 kg
	3/120x80	3/120x80	3/120x80
	3,8 m ³ /h	3,8 m ³ /h	3,8 m ³ /h
	✓	✓	✓
	500x500 cm	400x400 cm	350x350 cm



- Filtro cartucho
- Cartridge filter
- Filtre à cartouche
- Filtro a cartuccia



- Escalera de seguridad
- Safety ladder
- Échelle sécurité
- Scala di sicurezza

dream pool

serie HAITI



KITPROV8188

	KITPROV10288	KITPROV9188	KITPROV8188	KITPROV7388	KITPROV6188
	1000x550 cm	915x470 cm	800x470 cm	730x375 cm	610x375 cm
	132 cm	132 cm	132 cm	132 cm	132 cm
	56,11 m ³	43,59 m ³	37,47 m ³	28,21 m ³	23,28 m ³
	681 kg	570 kg	474 kg	348 kg	279 kg
	1/120x100	1/120x80	1/120x80	1/120x80	1/90x80
	10 m ³ /h	8 m ³ /h	8 m ³ /h	6 m ³ /h	6 m ³ /h
	✓	✓	✓	✓	✓
	✓	✓	✓	✓	✓
	1040x670 cm	955x590 cm	850x590 cm	770x495 cm	650x495 cm
	8 4 1208 1 224626	8 4 1208 1 220215	8 4 1208 1 224633	8 4 1208 1 220222	8 4 1208 1 221328

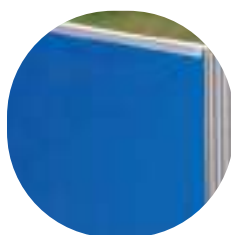

- Liner PVC azul 40/100
- PVC blue liner 40/100
- Liner PVC bleu 40/100
- Liner PVC blu 40/100



- Protectores de inyección
- Injection savers
- Protections moulées par injection
- Angolare di protezione



- Periferia de acero
- Bottom cover
- Poteaux et margelles acier
- Profili in acciaio



■ **Sistema de omegas**

Viga de acero enterrada de 15x15 cm que hace innecesarios los postes exteriores, obteniendo mejor aprovechamiento del jardín.

■ **Omega system**

15x15 cm buried steel beam makes unnecessary the outer buttress, optimizing the use of the garden area.

■ **Renforts enterrés**

Poteaux en acier à enterrer de 15x15 cm évitant des renforts apparents extérieurs, pour mieux profiter de l'espace du jardin.

■ **Sistema omega**

Barra di acciaio interrata da 15x15 cm che non rende necessario l'utilizzo delle barre laterali; permette di poter sfruttare al meglio gli spazi del proprio giardino.



- Depuradora arena
- Sand filter
- Filtre à sable
- Filtro a sabbia



- Escalera de seguridad
- Safety ladder
- Échelle sécurité
- Scala di sicurezza



- Tapiz protector
- Floor tapestry
- Tapis de sol en feutre
- Telo di protezione

dream pool

serie **ATLANTIS**



KITPROV918

	KITPROV1028	KITPROV918	KITPROV818	KITPROV738	KITPROV618	KITPROV508
	1000x550 cm	915x470 cm	800x470 cm	730x375 cm	610x375 cm	500x300 cm
	132 cm	132 cm	132 cm	132 cm	132 cm	132 cm
	56,11 m ³	43,59 m ³	37,47 m ³	28,21 m ³	23,28 m ³	16,21 m ³
	482 kg	466 kg	415 kg	348 kg	279 kg	260 kg
	1/120x100	1/120x80	1/120x80	1/120x80	1/90x80	1/90x80
	10 m ³ /h	8 m ³ /h	8 m ³ /h	6 m ³ /h	6 m ³ /h	6 m ³ /h
	✓	✓	✓	✓	✓	✓
	✓	✓	✓	✓	✓	✓
	1040x770 cm	955x690 cm	850x690 cm	770x595 cm	650x595 cm	540x520 cm

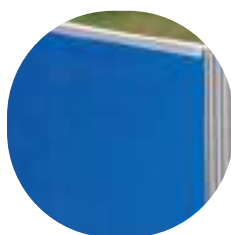

- Liner PVC azul 40/100
- PVC blue liner 40/100
- Liner PVC bleu 40/100
- Liner PVC blu 40/100



- Protectores de inyección
- Injection savers
- Protections moulées par injection
- Angolare di protezione

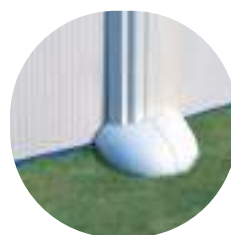

- Perfileria de acero
- Bottom cover
- Poteaux et margelles acier
- Profili in acciaio



KITPR558



	KITPR558	KITPR458	KITPR358
	Ø550 cm	Ø460 cm	Ø350 cm
	132 cm	132 cm	132 cm
	27,79 m ³	19,44 m ³	11,25 m ³
	243 kg	238 kg	184 kg
	1/90x80	1/90x80	1/90x80
	6 m ³ /h	6 m ³ /h	6 m ³ /h
	✓	✓	✓
	✓	✓	✓
	600x600 cm	500x500 cm	400x400 cm
	8 4 12081 211589	8 4 12081 211596	8 4 12081 233864



- Depuradora arena
- Sand filter
- Filtre à sable
- Filtro a sabbia



- Escalera de seguridad
- Safety ladder
- Échelle sécurité
- Scala di sicurezza



- Tapiz protector
- Floor tapestry
- Tapis de sol en feutre
- Telo di protezione

dream pool

serie **FIDJI**



KIT730ECO

	KIT730ECO	KIT610ECO	KIT500ECO
	730x375 cm	610x375 cm	500x300 cm
	120 cm	120 cm	120 cm
	25,32 m ³	20,89 m ³	14,55 m ³
	287 kg	235 kg	224 kg
	1/90x80	1/80x60	1/80x60
	4 m ³ /h	4 m ³ /h	4 m ³ /h
	✓	✓	✓
	770x595 cm	650x595 cm	540x520 cm

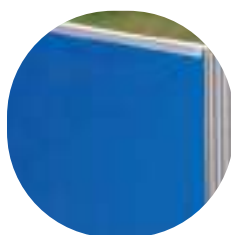

- Liner PVC azul 30/100
 - PVC blue liner 30/100
 - Liner PVC bleu 30/100
 - Liner PVC blu 30/100
- KIT730/610ECO: 40/100



- Protectores de inyección
- Injection savers
- Protections moulées par injection
- Angolare di protezione

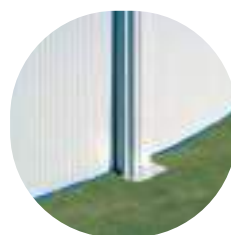

- Perfilera de acero
- Bottom cover
- Poteaux et margelles acier
- Profili in acciaio



KIT460ECO



	KIT550ECO	KIT460ECO	KIT350ECO	KIT300ECO	KIT240ECO
	Ø550 cm	Ø460 cm	Ø350 cm	Ø300 cm	Ø240 cm
	120 cm	120 cm	120 cm	120 cm	120 cm
	24,94 m ³	17,45 m ³	10,10 m ³	7,41 m ³	4,75 m ³
	209 kg	172 kg	146 kg	136 kg	126 kg
	1/80x60	1/80x60	1/80x60	1/80x60	1/80x60
	4 m ³ /h	4 m ³ /h	4 m ³ /h	4 m ³ /h	4 m ³ /h
	✓	✓	✓	✓	✓
	600x600 cm	500x500 cm	400x400 cm	350x350 cm	300x300 cm



8 4 12081 211411

8 4 12081 211428

8 4 12081 211435

8 4 12081 228754

8 4 12081 240831



- Depuradora arena
- Sand filter
- Filtre à sable
- Filtro a sabbia



- Escalera de seguridad
- Safety ladder
- Échelle sécurité
- Scala di sicurezza

dream pool

serie **VARADERO**



KITPROV6270

KITPROV6270

KITPROV4870

	640x390 cm	500x340 cm
	120 cm	120 cm
	20,65 m ³	13,69 m ³
	311 kg	284 kg
	1/90x80	1/90x80
	4 m ³ /h	4 m ³ /h
	✓	✓
	✓	✓
	700x430 cm	540x380 cm
	 8 4 1208 1 2 11633	 8 4 1208 1 2 31921

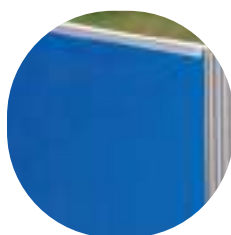

- Liner PVC azul 40/100
- PVC blue liner 40/100
- Liner PVC bleu 40/100
- Liner PVC blu 40/100



- Protectores de inyección
- Injection savers
- Protections moulées par injection
- Angolare di protezione

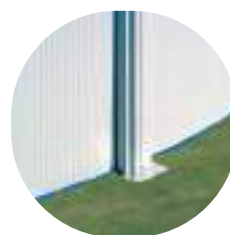

- Perfilera de acero
- Bottom cover
- Poteaux et margelles acier
- Profili in acciaio



■ Sistema de omegas

Viga de acero enterrada de 15x15 cm que hace innecesarios los postes exteriores, obteniendo mejor aprovechamiento del jardín.

■ Omega system

15x15 cm buried steel beam makes unnecessary the outer buttress, optimizing the use of the garden area.

■ Renforts enterrés

Poteaux en acier à enterrer de 15x15 cm évitant des renforts apparents extérieurs, pour mieux profiter de l'espace du jardin.

■ Sistema omega

Barra di acciaio interrata da 15x15 cm che non rende necessario l'utilizzo delle barre laterali; permette di poter sfruttare al meglio gli spazi del proprio giardino.

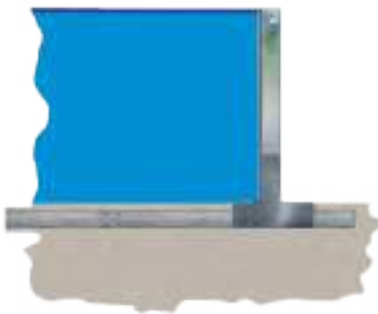

- Depuradora arena
- Sand filter
- Filtre à sable
- Filtro a sabbia



- Escalera de seguridad
- Safety ladder
- Échelle sécurité
- Scala di sicurezza



- Tapiz protector
- Floor tapestry
- Tapis de sol en feutre
- Telo di protezione

dream pool



serie **BORA BORA**



KITPROV613

KITPROV613

KITPROV503

	610x375 cm	500x300 cm
	120 cm	120 cm
	20,89 m ³	14,55 m ³
	210 kg	205 kg
	1/80x60	1/80x60
	3,8 m ³ /h	3,8 m ³ /h
	✓	✓
	650x595 cm	540x520 cm



8 4 12081 220437



8 4 12081 220260

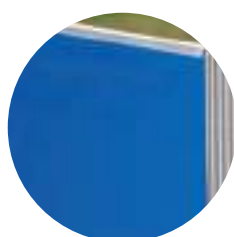

- Liner PVC azul 30/100
 - PVC blue liner 30/100
 - Liner PVC bleu 30/100
 - Liner PVC blu 30/100
- KITPROV613: 40/100



- Protectores de inyección
- Injection savers
- Protections moulées par injection
- Angolare di protezione

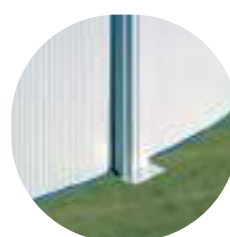

- Perfileria de acero
- Bottom cover
- Poteaux et margelles acier
- Profili in acciaio



KITPR453



	KITPR453	KITPR353	KITPR303
	Ø460 cm	Ø350 cm	Ø300 cm
	120 cm	120 cm	120 cm
	17,45 m ³	10,10 m ³	7,41 m ³
	149 kg	109 kg	94 kg
	1/80x40	1/80x40	1/80x40
	3,8 m ³ /h	3,8 m ³ /h	3,8 m ³ /h
	✓	✓	✓
	500x500 cm	400x400 cm	350x350 cm
	 8 4 12081 209005	 8 4 12081 209012	 8 4 12081 233901

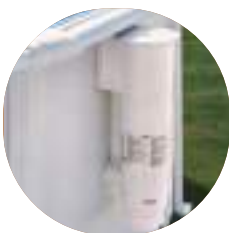

- Filtro cartucho
- Cartridge filter
- Filtre à cartouche
- Filtro a cartuccia



- Escalera de seguridad
- Safety ladder
- Échelle sécurité
- Scala di sicurezza



■ LA PISCINA CON ALAS

Mariposa es una pequeña piscina similar a una frágil mariposa blanca que se encuentra en una superficie o terraza. Fácil de instalar, en menos de una hora, no es necesario ningún tipo de construcción, se monta y está lista para usar. Las alas de Mariposa son cómodas tumbonas con respaldo ajustable en la parte baja de la espalda en diferentes posiciones.

El diseño elegante y sofisticado encaja como un objeto decorativo en la zona exterior de cualquier casa.

■ LA PISCINE AVEC DES AILES

Mariposa est un petit bassin semblable à un fragile papillon blanc qui se trouve sur une surface ou une terrasse. Facile à installer, en moins d'une heure, aucune construction n'est nécessaire, il est assemblé et prêt à être utilisé. Les ailes de papillon sont des chaises longues confortables avec un dossier réglable dans le bas du dos dans différentes positions.

Son design élégant et sophistiqué s'intègre comme un objet décoratif dans l'espace extérieur de toute maison.

■ THE POOL WITH WINGS

Mariposa is a small pool similar to a fragile white butterfly that sits on a surface or terrace. Easy to install, in less than an hour, no construction is required, it is assembled and ready to use. The Butterfly wings are comfortable loungers with adjustable backrest in the lower back in different positions.

The elegant and sophisticated design fits as a decorative object in the outdoor area of any house.

■ LA PISCINA CON LE ALI

Mariposa è una piccola piscina simile a una fragile farfalla bianca che si trova su una superficie o una terrazza. Facile da installare, in meno di un'ora, nessuna costruzione è richiesta, è montato e pronto all'uso. Le ali Butterfly sono comodi lettini con schienale regolabile nella parte bassa della schiena in diverse posizioni.

Il design elegante e sofisticato si adatta come un oggetto decorativo nella zona esterna di qualsiasi casa.



- Un nuevo concepto de piscina: relax y diseño
- A new relaxing & design pool concept
- Un nouveau concept de piscine relaxante et design
- Un nuovo concetto di piscina rilassante e di design



PBT201 282x219 cm 60 cm 1,05 m³ 93 kg 1/80x70 3 m³/h 2 332x269 cm 8 4 1208 11 3 18288

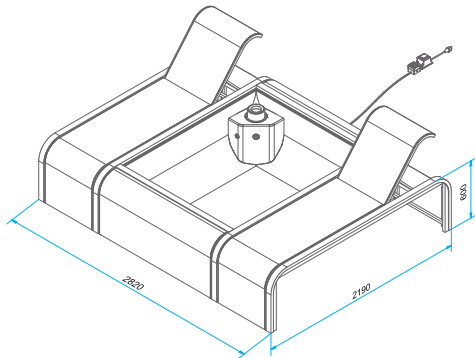

- Montaje de una piscina Mariposa
- Mariposa pool assembly
- Installation de piscine Mariposa
- Installazione di una piscina Mariposa

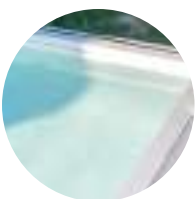

- Liner reforzado 0,85 mm
- Reinforced liner 0,85 mm
- Revêtement renforcé de 0,85mm
- Liner rinforzato 0,85 mm



- Tumbonas de diseño italiano de alta resistencia
- Italian design sunbeds of high resistance
- Solarium de design italien de haute résistance
- Lettini di design italiano ad alta resistenza



- Cartucho interior filtro 3 m³/h
- Interior cartridge filter 3 m³/h
- Filtre intérieur à cartouches 3 m³/h
- Filtro a cartuccia interno 3 m³/h

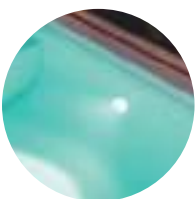

- Luz LED 3,6 W
- LED Light 3,6 W
- Lumière LED 3,6 W
- Luce LED 3,6 W



- Limpiafondos de aspiración y mangueras
- Suction pool cleaner and hoses
- Nettoyeurs de piscine et tuyaux
- Pulitori di piscine ad aspirazione e tubi flessibili d'aspirazione



- Cubierta de invierno
- Winter cover
- Couverture hivernale
- Copertura invernale

atolón in-ground pool



■ **PISCINA ENTERRADA DE PARED DE ACERO**

LINER: tratamiento Anti - Ultravioleta que retrasa el envejecimiento del P.V.C.

CHAPA: laminada en frío con tratamiento de galvanización, fosfatación, imprimación y lacado.

Troquelada para skimmer y válvula de retorno y limpiafondos y focos.

■ **PISCINES ENTERRÉES AVEC PAROIS EN ACIER**

LINER : traitement anti-ultraviolets contre le vieillissement du P.V.C.

TÔLE : tôle laminée à froid et traitée par galvanisation, phosphatage, couche d'apprêt et laquage.

Découpage pour le skimmer, la buse de refoulement et la prise balai. Prédécoupe pour les projecteurs.



■ **IN-GROUND STEEL WALL POOL**

LINER: anti-ultraviolet treatment to slow down P.V.C aging.

PLATE: galvanized, phosphatized, primed and lacquered cold-rolled plate .

Die cut for skimmer, return valve and cleaner openings and lights.

■ **PISCINE INTERRATA CON PARETI IN ACCIAIO**

LINER: Trattamento Anti-ultravioletti - Ritarda l'invecchiamento del P.V.C.

PANNELLO: Laminata a freddo con trattamento di galvanizzazione, fosfatazione e preparazione.

Stampigliatura per Skimmer, valvola di ritorno e puliscifondi e spot.



in-ground pool

serie **MOOREA**



	KPEOV8059M	KPEOV7059M	KPEOV6059M	KPEOV5059M
	800x400 cm	700x320 cm	600x320 cm	500x300 cm
	150 cm	150 cm	150 cm	150 cm
	38,84 m ³	27,47 m ³	24,42 m ³	16,01 m ³
	217/232 kg	189/232 kg	164/232 kg	139/232 kg
	1/120x80 1/90x80	1/120x80 1/90x80	1/120x80 1/90x80	1/120x80 1/90x80
	10 m ³ /h	10 m ³ /h	10 m ³ /h	8 m ³ /h
	✓	✓	✓	✓
	✓	✓	✓	✓
	1000x600x165 cm	900x520x165 cm	800x520x165 cm	700x500x165 cm
	 8 4 1208 1 269597	 8 4 1208 1 269603	 8 4 1208 1 269610	 8 4 1208 1 269627



- Liner PVC azul 75/100
- PVC blue liner 75/100
- Liner PVC bleu 75/100
- Liner PVC blu 75/100

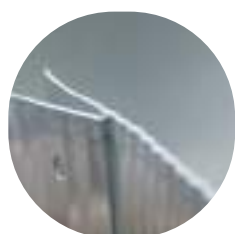

- Chapa prelacada 70/100
- Prelacquered steel 70/100
- Tôle prélaquée 70/100
- Lamiera laccata 70/100



- Depuradora arena
- Sand filter
- Filtre à sable
- Filtro a sabbia



KPE4259M

	Ø420 cm
	150 cm
	18,84 m ³
	126/232 kg
	1/120x80 1/90x80
	8 m ³ /h
	✓
	✓
	Ø620x165 cm



- Escalera fácil acceso: 3 peldaños. Inox.
- Easy access ladder: 3 steps. Stainless steel
- Échelle d'accès facile: 3 marches. Acier inoxydable
- Scala di accesso facile: 3 gradini. Inox



- Manta protectora (Poliéster)
- Bottom protectiveblanket (Polyester)
- Tapis de sol en feutre (Polyester)
- Telo di protezione (Poliestere)



- Skimmer, manguera, raccordería...
- Skimmer, hose, fittings...
- Skimmer, tuyau, raccords...
- Skimmer, tubo, raccordería...

in-ground pool

serie

MADAGASCAR



	KPEOV8059	KPEOV7059	KPEOV6059	KPEOV5059
	800x400 cm	700x320 cm	600x320 cm	500x300 cm
	150 cm	150 cm	150 cm	150 cm
	38,84 m ³	27,47 m ³	24,42 m ³	16,01 m ³
	217/224 kg	189/224 kg	164/224 kg	139/224 kg
	1/120x80 1/90x80	1/120x80 1/90x80	1/120x80 1/90x80	1/120x80 1/90x80
	10 m ³ /h	10 m ³ /h	10 m ³ /h	8 m ³ /h
	✓	✓	✓	✓
	✓	✓	✓	✓
	1000x600x165 cm	900x520x165 cm	800x520x165 cm	700x500x165 cm
	 8 4 1208 1 269320	 8 4 1208 1 269337	 8 4 1208 1 269344	 8 4 1208 1 258904



- Liner PVC azul 75/100
- PVC blue liner 75/100
- Liner PVC bleu 75/100
- Liner PVC blu 75/100

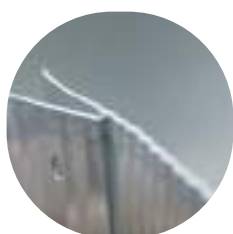











- Chapa prelacada 70/100
- Prelacquered steel 70/100
- Tôle prélaquée 70/100
- Lamiera laccata 70/100



- Depuradora arena
- Sand filter
- Filtre à sable
- Filtro a sabbia



KPE4259

	Ø420 cm
	150 cm
	18,84 m ³
	126/224 kg
	1/120x80 1/90x80
	8 m ³ /h
	✓
	✓
	Ø620x165 cm
	 8 412081 269351



- Escalera: 4 peldaños. Inox.
- Ladder: 4 steps. Stainless steel
- Échelle: 4 marches. Acier inoxidable
- Scala: 4 gradini. Inox



- Manta protectora (Poliéster)
- Bottom protectiveblanket (Polyester)
- Tapis de sol en feutre (Polyester)
- Telo di protezione (Poliestere)



- Skimmer, manguera, raccordería...
- Skimmer, hose, fittings...
- Skimmer, tuyau, raccords...
- Skimmer, tubo, raccordería...

in-ground pool

serie **SUMATRA**



	KPEOV8027	KPEOV7027	KPEOV6027	KPEOV5027
	800x400 cm	700x320 cm	600x320 cm	500x300 cm
	120 cm	120 cm	120 cm	120 cm
	30,00 m ³	21,21 m ³	17,85 m ³	12,36 m ³
	193/222 kg	173/222 kg	154/222 kg	134/222 kg
	1/120x80 1/90x80	1/120x80 1/90x80	1/120x80 1/90x80	1/120x80 1/90x80
	10 m ³ /h	10 m ³ /h	10 m ³ /h	8 m ³ /h
	✓	✓	✓	✓
	✓	✓	✓	✓
	1000x600x135 cm	900x520x135 cm	800x520x135 cm	700x500x135 cm
	8 4 12081 269368	8 4 12081 269375	8 4 12081 269382	8 4 12081 258959



- Liner PVC azul 60/100
- PVC blue liner 60/100
- Liner PVC bleu 60/100
- Liner PVC blu 60/100

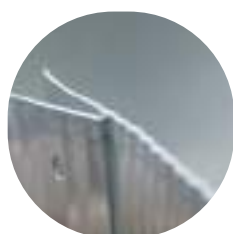

- Chapa prelacada 60/100
- Prelacquered steel 60/100
- Tôle prélaquée 60/100
- Lamiera laccata 60/100



- Depuradora arena
- Sand filter
- Filtre à sable
- Filtro a sabbia



KPE4227

KPE3527

	Ø420 cm	Ø350 cm
	120 cm	120 cm
	14,54 m ³	10,10 m ³
	222/102 kg	222/85 kg
	1/120x80 1/90x80	1/120x80 1/90x80
	8 m ³ /h	8 m ³ /h
	✓	✓
	✓	✓
	Ø620x135 cm	Ø550x135 cm



8 4 12081 269399



8 4 12081 262635



- Escalera 3 peldaños. Inox.
- Ladder: 3 steps. Stainless steel
- Échelle 3 marches. Acier inoxydable
- Scala 3 gradini. Inox



- Manta protectora (Poliéster)
- Bottom protectiveblanket (Polyester)
- Tapis de sol en feutre (Polyester)
- Telo di protezione (Poliestere)



- Skimmer, manguera, raccordería...
- Skimmer, hose, fittings...
- Skimmer, tuyau, raccords...
- Skimmer, tubo, raccordería...

complements



■ Complementos

Cubiertas isotérmicas para piscinas de madera
 Cubiertas de invierno para piscinas de madera
 Cubiertas isotérmicas para piscinas de composite
 Cubiertas de invierno para piscinas de composite
 Cubiertas isotérmicas para piscinas enterradas
 Cubiertas isotérmicas
 Cubiertas de invierno
 Enrolladores de cubiertas
 Mantas
 Protectores
 Liners
 Reparadores de liner
 Escaleras para piscinas enterradas
 Escaleras para piscinas sobre suelo
 Escaleras para piscina de madera
 Deporte en la piscina
 Seguridad piscina
 Monoblocs de filtración
 Bombas
 Filtros Aqualoon
 Locales técnicos
 Filtros de Cartucho
 Cartuchos
 Mangueras de filtración
 Adaptadores
 Cargas filtrantes
 Skimmers
 Repuestos de filtración
 Conectividad
 Blue Connect
 Electrolisis de sal
 Sistemas de dosificación
 Iluminación
 Calefacción solar
 Calefacción
 Duchas
 Racordería

■ Complements

Wooden pool isothermic covers
 Wooden pool winter covers
 Composite pool isothermic covers
 Composite pool winter covers
 In ground pool isothermic covers
 Isothermic covers
 Winter covers
 Telescopic cover rollers
 Bottom protective blankets
 Protectors
 Liners
 Liner repairs
 Inground pool ladders
 Above-ground pool ladders
 Wooden pool ladder
 Pool Fitness
 Pool security
 Filtration kit
 Pumps
 Aqualoon filters
 Technical rooms
 Cartridge filter
 Cartridges
 Filtration hoses
 Adapters
 Filter media
 Skimmers
 Filtration spare parts
 Connectivity
 Blue Connect
 Electrolysis of salt
 Dosing systems
 Lighting
 Solar heating system
 Heating systems
 Showers
 PVC Fittings

88
90
92
92
93
94
95
96
98
100
102
107
108
110
112
112
113
114
116
117
119
120
120
121
122
123
123
124
127
128
130
132
133
137
138
140
148

■ Compléments

Bâches été pour piscines bois
 Bâches hiver pour piscines bois
 Bâches été pour piscines composite
 Bâches hiver pour piscines composite
 Bâches été pour piscines enterrées
 Couvertures isothermes
 Couvertures d'hivernage
 Enrouleurs de bâches
 Tapis de sol
 Protecteurs
 Liners
 Réparation liner
 Échelles pour piscines enterrées
 Échelles pour piscines hors sol
 Échelle pour piscines bois
 Fitness piscine
 Protection pour piscine
 Filtres a sable
 Pompes
 Filtre a Aqualoon
 Local technique
 Epurateurs à cartouche
 Cartouches
 Tuyaux pour épurateurs
 Adaptateurs
 Médias filtrants
 Skimmers
 Accessoires pour filtration
 Connectivité
 Blue Connect
 Electrolyse au sel
 Système de dosage
 Éclairage
 Chauffage solaire
 Chauffage
 Douches
 Raccords PVC

■ Complementi

Coperture isothermiche per piscine in legno
 Copertura invernale per piscine in legno
 Coperture isothermiche per piscine composite
 Copertura invernale per piscine composite
 Copertura isothermiche per piscine interrata
 Coperture isothermiche
 Copertura invernale
 Avvolgitore
 Telo di protezione fondi
 Protezioni
 Liners
 Riparazione liner
 Scaletta per piscina interrata
 Scaletta per piscina fuori terra
 Scaletta per piscina in legno
 Fitness in piscina
 Protezione per piscine
 Filtro monoblocco
 Pompe
 Filtro a Aqualoon
 Locale tecnico
 Filtri a cartuccia
 Cartucce
 Tubi di filtraggio
 Adattatori
 Carico filtrante
 Skimmers
 Filtraggio parti
 Connettività
 Blue Connect
 Elettrolisi salina
 Sistemi di dosaggio
 Illuminazione
 Riscaldamento solare
 Riscaldamento
 Docce
 Raccorderia in PVC

■ complementos ■ complements ■ complements ■ complementi

■ CUBIERTAS ISOTÉRMICAS PARA PISCINAS DE MADERA

■ ISOTHERMIC COVERS FOR WOODEN POOLS

■ BÂCHES ÉTÉ POUR PISCINES BOIS

■ COPERTURE ISOTERMICHE PER PISCINE IN LEGNO



■ Material: Polietileno ■ Material: Polyethylene ■ Matériau: Polyéthylène ■ Materiale: Polietilene



786642	1157 x 366 cm	400 µ		CARDAMON 788033	BXL PACK 1	3	
786641	960 x 366 cm	400 µ		MINT 788032	BXL PACK 1	3	
CV790207	762 x 368 cm	400 µ		BRAGA 790207	BXL PACK 1	8	
CV800009	480 x 368 cm	400 µ		EVORA PLUS 800009	BXL PACK 1	8	
CV790206	565 x 368 cm	400 µ		EVORA 790206	BXL PACK 1	8	
CV7900962	368 x 218 cm	400 µ		MARBELLA 2 7900962	BXL PACK 1	8	
788453	374 x 224 cm	400 µ		MARBELLA 790096	BXL PACK 1	3	
CVKPBRC620	565 x 268 cm	400 µ		MANGO KPBRC620	BXL PACK 1	8	
CV790204	345 x 170 cm	400 µ		LEMON 790204	BXL PACK 1	8	
CV790205	268 x 268 cm	400 µ		CARRA 790205	BXL PACK 1	8	
CV790000	195 x 195 cm	400 µ		CITY 790000	BXL PACK 1	8	
CV790208	800 x 403 cm	400 µ	SEVILLA 790208		BXL PACK 1	8	



- Ventajas de utilizar una cubierta
- Benefits of using a pool cover
- Avantages de l'utilisation d'une couverture
- Vantaggi dell'utilizzo di una copertura



						
CV800007	700 x 403 cm	400 µ	ORANGE 800007		BXL PACK 1	8 4 1208 1 3 1334 4
786634	618 x 418 cm	400 µ	VERMELA 790098		BXL PACK 1	3 6052 17 8663 49
CV790203	603 x 403 cm	400 µ	AVOCADO 790203		BXL PACK 1	8 4 1208 1 3 0828 9
CV7900892	568 x 343 cm	400 µ	SAFRAN 2 7900892		BXL PACK 1	8 4 1208 1 3 4566 6
784800	585 x 358 cm	400 µ	SAFRAN 790089		BXL PACK 1	3 6052 17 8480 00
CV7900872	482 x 281 cm	400 µ	CANELLE 2 7900872		BXL PACK 1	8 4 1208 1 3 1853 0
779532	498 x 298 cm	400 µ	CANELLE 790087		BXL PACK 1	3 6052 17 7953 28
CV7900862	382 x 281 cm	400 µ	GRENADE 2 7900862		BXL PACK 1	8 4 1208 1 3 1854 7
779530	398 x 298 cm	400 µ	GRENADE 790086		BXL PACK 1	3 6052 17 7953 04
790073	568 x 343 cm	400 µ	CAMOMILLE 790202		BXL PACK 1	3 6052 17 9007 39
CVKPBOC632	580 x 282 cm	400 µ	MACADAMIA KPBOC632		BXL PACK 1	8 4 1208 1 2 734 88
CVKPBOC535	482 x 282 cm	400 µ	BAMBU KPBOC535		BXL PACK 1	8 4 1208 1 2 734 71
CV800003	ø 436 cm	400 µ	VIOLETTE 2 800003		BXL PACK 1	8 4 1208 1 3 1330 6
CV790210	ø 371 cm	400 µ	VASTO 790302 ANANAS 790210		BXL PACK 1	8 4 1208 1 3 0827 2
CV800002	ø 337 cm	400 µ	VANILLE 2 800002		BXL PACK 1	8 4 1208 1 3 1327 6
CV800008	ø 237 cm	400 µ	LILI 2 800008		BXL PACK 1	8 4 1208 1 3 1324 5

■ complementos ■ complements ■ complements ■ complementi

- CUBIERTAS DE INVIERNO PARA PISCINAS DE MADERA
- WINTER COVERS FOR WOODEN POOLS
- BÂCHES HIVER POUR PISCINES BOIS
- COPERTURE INVERNALE PER PISCINE IN LEGNO



■ Material: PVC armado ■ Material: Armed PVC ■ Matériau: PVC armé ■ Materiale: PVC armato

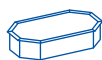

778042	1258 x 467 cm	580 g/m ²	CARDAMON 788033	BXL PACK 1	3 605217 780423
778041	1058 x 467 cm	580 g/m ²	MINT 788032	BXL PACK 1	3 605217 780416
CI790207	855 x 460 cm	580 g/m ²	BRAGA 790207	BXL PACK 1	8 412081 308425
CI790206	658 x 460 cm	580 g/m ²	EVORA 790206 EVORA PLUS 800009	BXL PACK 1	8 412081 308432
788452	467 x 317 cm	580 g/m ²	MARBELLA 790096	BXL PACK 1	3 605217 884527
CIKPBRC620	658 x 360 cm	580 g/m ²	MANGO KPBRC620	BXL PACK 1	8 412081 273549
CI790204	414 x 239 cm	580 g/m ²	LEMON 790204	BXL PACK 1	8 412081 308388
CI790205	335 x 335 cm	580 g/m ²	CARRA 790205	BXL PACK 1	8 412081 308395
790001	250 x 250 cm	580 g/m ²	CITY 790000	BXL PACK 1	3 605217 900012
CI790208	893 x 496 cm	580 g/m ²	SEVILLA 790208	BXL PACK 1	8 412081 308418
CI800007	793 x 496 cm	580 g/m ²	ORANGE 800007	BXL PACK 1	8 412081 313337



- Ventajas de utilizar una cubierta
- Benefits of using a pool cover
- Avantages de l'utilisation d'une couverture
- Vantaggi dell'utilizzo di una copertura

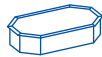

621103	712 x 512 cm	580 g/m ²	VERMELA 790098	BXL PACK 1	3 605216 211034
779537	676 x 451 cm	580 g/m ²	SAFRAN 790089 SAFRAN 2 7900892	BXL PACK 1	3 605217 795373
786754	591 x 391 cm	580 g/m ²	CANELLE 790087 CANELLE 2 7900872	BXL PACK 1	3 605217 867544
779531	476 x 376 cm	580 g/m ²	GRENADE 790086 GRENADE 2 7900862	BXL PACK 1	3 605217 795311
CI790203	696 x 497 cm	580 g/m ²	AVOCADO 790203	BXL PACK 1	8 412081 308371
790063	661 x 436 cm	580 g/m ²	CAMOMILLE 790202	BXL PACK 1	3 605217 900630
CIKPBOC632	675 x 375 cm	580 g/m ²	MACADAMIA KPBOC632	BXL PACK 1	8 412081 273525
CIKPBOC535	575 x 375 cm	580 g/m ²	BAMBU KPBOC535	BXL PACK 1	8 412081 273518
784801	ø 550 cm	580 g/m ²	VIOLETTE 2 800003 VIOLETTE 790085	BXL PACK 1	3 605217 848017
779525	ø 440 cm	580 g/m ²	VANILLE 2 800002 VANILLE 790083	BXL PACK 1	3 605217 795250
787058	ø 325 cm	580 g/m ²	LILI 2 800008 LILI 790080	BXL PACK 1	3 605217 870582
CI790210	ø 468 cm	580 g/m ²	VASTO 790302 ANANAS 790210	BXL PACK 1	8 412081 308364

■ complementos ■ complements ■ complements ■ complementi

- CUBIERTAS ISOTÉRMICAS PARA PISCINAS DE COMPOSITE
- ISOTHERMIC COVERS FOR COMPOSITE POOL
- BÂCHES ÉTÉ POUR PISCINES COMPOSITE
- COPERTURE ISOTERMICHE PER PISCINE COMPOSITE



■ Material: Polietileno ■ Material: Polyethylene ■ Matériau: Polyéthylène ■ Materiale: Polietilene

CVKPCOR60	560 x 280	400 µ			606 x 326		BXL PACK 1	8 4 1208 1 273709
CVKPCOR46	420 x 280	400 µ			466 x 326		BXL PACK 1	8 4 1208 1 304885
CVKPCOR2814	275 x 135	400 µ			326 x 186		BXL PACK 1	8 4 1208 1 304977
CVKPCOR28	275 x 275	400 µ				326 x 326	BXL PACK 1	8 4 1208 1 302690
CVKPCO80	753 x 333	400 µ	804 x 386				BXL PACK 1	8 4 1208 1 270661
CVKPCO66	613 x 333	400 µ	664 x 386				BXL PACK 1	8 4 1208 1 270654
CVKPCO52	473 x 333	400 µ	524 x 386				BXL PACK 1	8 4 1208 1 270647
CVKPCO41	Ø 361	400 µ		Ø 410			BXL PACK 1	8 4 1208 1 270630

- CUBIERTAS DE INVIERNO PARA PISCINAS DE COMPOSITE
- WINTER COVERS FOR COMPOSITE POOLS
- BÂCHES HIVER POUR PISCINES COMPOSITE
- COPERTURE INVERNALI PER PISCINE COMPOSITE

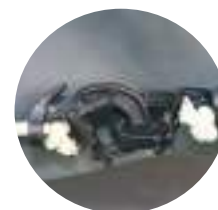







■ Material: PVC armado ■ Material: Armed PVC ■ Matériau: PVC armé ■ Materiale: PVC armato

CIKPCOR60	656 x 376	580 g/m ²			606 x 326		BXL PACK 1	8 4 1208 1 273723
CIKPCOR46	516 x 376	580 g/m ²			466 x 326		BXL PACK 1	8 4 1208 1 304892
CIKPCOR2814	376 x 236	580 g/m ²			326 x 186		BXL PACK 1	8 4 1208 1 304984
CIKPCOR28	376 x 376	580 g/m ²				326 x 326	BXL PACK 1	8 4 1208 1 302706
CIKPCO80	854 x 436	580 g/m ²	804 x 386				BXL PACK 1	8 4 1208 1 270708
CIKPCO66	714 x 436	580 g/m ²	664 x 386				BXL PACK 1	8 4 1208 1 270692
CIKPCO52	574 x 436	580 g/m ²	524 x 386				BXL PACK 1	8 4 1208 1 270685
CIKPCO41	Ø 460	580 g/m ²		Ø 410			BXL PACK 1	8 4 1208 1 270678

- CUBIERTAS ISOTÉRMICAS PARA PISCINAS ENTERRADAS
- IN-GROUND POOLS ISOTHERMIC COVERS
- BÂCHES ÉTÉ POUR PISCINES ENTERRÉES
- COPERTURE ISOTERMICHE PER PISCINE INTERRATA



■ Material: Polietileno ■ Material: Polyethylene ■ Matériau: Polyéthylène ■ Materiale: Polietilene

							
CVPE800	795 x 395	400 µ	800 x 400			BXL PACK 1	8 412081 273907
CVPE700	695 x 315	400 µ	700 x 320			BXL PACK 1	8 412081 273914
CVPE600	595 x 315	400 µ	600 x 320			BXL PACK 1	8 412081 273921
CVPE550	Ø 545	400 µ		Ø 550		BXL PACK 1	8 412081 308449
CVPE500	495 x 295	400 µ	500 x 300			BXL PACK 1	8 412081 273938
CVPE420	Ø 415	400 µ		Ø 420		BXL PACK 1	8 412081 273945
CVPE350	Ø 345	400 µ		Ø 350		BXL PACK 1	8 412081 273952
CVPE300	Ø 295	400 µ		Ø 300		BXL PACK 1	8 412081 308456
CPERT105	1000 x 500	180 µ			1000 x 500	BXL PACK 1	8 412081 268354
CPERT95	900 x 500	180 µ			900 x 500	BXL PACK 1	8 412081 268347
CPERT84	800 x 400	180 µ			800 x 400	BXL PACK 1	8 412081 268330
CPERT63	600 x 300	180 µ			600 x 300	BXL PACK 1	8 412081 268323
CPERT53	500 x 300	180 µ			500 x 300	BXL PACK 1	8 412081 268316

■ complementos ■ complements ■ complements ■ complementi

- CUBIERTAS ISOTÉRMICAS
- ISOTHERMIC COVERS
- COUVERTURES ISOTHERMES
- COPERTURE ISOTERMICHE

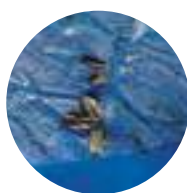

■ Material: Polietileno ■ Material: Polyethylene ■ Matériau: Polyéthylène ■ Materiale: Polietilene



CPROV1020	995 x 545	180 μ	1000 x 550				PBH PACK 1	8 4 1208 1 220536
CPROV915	910 x 460	180 μ	915 x 470				PBH PACK 1	8 4 1208 1 980324
CPROV810	805 x 460	180 μ	800 x 470				PBH PACK 1	8 4 1208 1 205984
CPROV730	725 x 370	180 μ	730 x 375				PBH PACK 1	8 4 1208 1 980331
CPROV610	605 x 370	180 μ	610 x 375				PBH PACK 1	8 4 1208 1 205991
CPROV510	485 x 335	180 μ	500 x 350				PBH PACK 1	8 4 1208 1 268811
CPROV505	495 x 295	180 μ	500 x 300				PBH PACK 1	8 4 1208 1 221823
CPROV700	672 x 445	180 μ		710 x 475			PBH PACK 1	8 4 1208 1 205830
CPROV600	620 x 370	180 μ		640 x 390			PBH PACK 1	8 4 1208 1 205847
CPROV500	472 x 305	180 μ		500 x 340			PBH PACK 1	8 4 1208 1 205854
CPR650	∅ 635	180 μ			∅ 640		PBH PACK 1	8 4 1208 1 950303
CPR550	∅ 545	180 μ			∅ 550		PBH PACK 1	8 4 1208 1 940601
CV450	∅ 455	180 μ	∅ 550		∅ 460	∅ 450/460	PBH PACK 1	8 4 1208 1 202525
CPR400	∅ 395	180 μ				∅ 400	PBH PACK 1	8 4 1208 1 940625
CV350	∅ 345	180 μ	∅ 450		∅ 350	∅ 350	PBH PACK 1	8 4 1208 1 202532
CV300	∅ 295	180 μ	∅ 350		∅ 300	∅ 300	PBH PACK 1	8 4 1208 1 202549
CV250	∅ 245	180 μ	∅ 300		∅ 240		PBH PACK 1	8 4 1208 1 208565
CVP1000	1000 x 550	400 μ	1000 x 550				PBH PACK 1	8 4 1208 1 318424
CVP900	910 x 460	400 μ	915 x 470				PBH PACK 1	8 4 1208 1 318417
CVP800	800 x 470	400 μ	810 x 470				PBH PACK 1	8 4 1208 1 318400
773326	725 x 370	400 μ	730 x 375				PBH PACK 1	3 605217 733269
773324	605 x 370	400 μ	610 x 375				PBH PACK 1	3 605217 733245
773322	495 x 295	400 μ	500 x 300				PBH PACK 1	3 605217 733221
773320	∅ 550	400 μ	∅ 555		∅ 550		PBH PACK 1	3 605217 733207
772999	∅ 460	400 μ	∅ 465		∅ 460		PBH PACK 1	3 605217 729996
772997	∅ 460	400 μ	∅ 365		∅ 360		PBH PACK 1	3 605217 729972

- CUBIERTAS DE INVIERNO
- WINTER COVERS
- COUVERTURES POUR L'HIVER
- COPERTURA INVERNALE



■ Material: Polietileno ■ Material: Polyethylene ■ Matériau: Polyéthylène ■ Materiale: Polietilene



CIPROV731P	820 x 460	180 g/m ²		730 x 375	640 x 390		CBX PACK 3	8 4 12081 306957
CIPROV611P	680 x 460	180 g/m ²		610 x 375	500 x 340		CBX PACK 3	8 4 12081 306964
CIPROV501P	610 x 410	180 g/m ²		500 x 300			CBX PACK 3	8 4 12081 306971
CIPR451P	ø 540	180 g/m ²	ø 550		ø 460 ø 400		CBX PACK 5	8 4 12081 306988
CIPR351P	ø 440	180 g/m ²	ø 350 ø 360		ø 350 ø 350		CBX PACK 5	8 4 12081 306995
CIPROV1001	1115 x 660	120 g/m ²		1000 x 550			CBX PACK 3	8 4 12081 221854
CIPROV911	1030 x 560	120 g/m ²		915 x 470			CBX PACK 3	8 4 12081 208671
CIPROV821	930 x 560	120 g/m ²		800 x 470	710 x 475		CBX PACK 3	8 4 12081 208688
CIPROV731	820 x 460	120 g/m ²		730 x 375	640 x 390		CBX PACK 3	8 4 12081 208695
CIPROV611	680 x 460	120 g/m ²		610 x 375	500 x 340		CBX PACK 3	8 4 12081 208701
CIPROV501	610 x 410	120 g/m ²		500 x 300			CBX PACK 3	8 4 12081 221861
CIPR651	ø 730	120 g/m ²			ø 640		CBX PACK 3	8 4 12081 208718
CIPR551	ø 640	120 g/m ²			ø 550		CBX PACK 5	8 4 12081 208725
CIPR451	ø 540	120 g/m ²	ø 550		ø 460 ø 450 ø 460		CBX PACK 5	8 4 12081 208732
CIPR401	ø 480	120 g/m ²	ø 440 ø 450		ø 400		CBX PACK 5	8 4 12081 208749
CIPR351	ø 440	120 g/m ²	ø 360 ø 350 ø 360		ø 350 ø 350		CBX PACK 5	8 4 12081 208756
CIPR301	ø 380	120 g/m ²			ø 300		CBX PACK 5	8 4 12081 220567
CIPR241	ø 330	120 g/m ²			ø 240		CBX PACK 5	8 4 12081 220574

■ complementos ■ complements ■ complements ■ complementi

■ ENROLLADORES DE CUBIERTAS ■ TELESCOPIC COVER ROLLERS
■ ENROULEURS DE BÂCHES ■ AVVOLGITORE PER PISCINE



90171

■ **Enrollador de cubierta para piscinas enterradas.** Se desenrolla hasta 5,50m. Ideal para piscinas redondas, cuadradas u ovaladas. Contiene tubos redondos en aluminio anodizado, un volante ergonómico con empuñadura giratoria y un kit para atar la cubierta.

■ **Cover roller for in ground pools.** Unfolds to a maximum length of 5.50 m. Suitable for round, square or oval swimming pools. Includes round anodised aluminium tubes, an ergonomic hand wheel with revolving handle as well as a kit to attach it to the cover.

■ **Enrouleur de bâches pour piscines enterrées.** Il offre un développement maximum de 5,50m. Il convient aux piscines rondes, carrées ou ovales. Il est équipé de tubes ronds en aluminium anodisés, d'un volant ergonomique avec poignée tournante et d'un kit d'attache pour bâche.

■ **Avvolgitore "grandi ruote" per piscine interrante.** Si srotola fino a un massimo di 5.50m. Adatto per le piscine tonde, quadrate e ovali. Contiene un tubo in alluminio anodizzato, una ghiera ergonomica con una impugnatura rotatoria e un kit per fissare la copertura. Consegnato in un unico imballo.



90172

■ **Enrollador de cubierta para piscinas enterradas.** Se desenrolla hasta 5,50m. Ideal para piscinas redondas, cuadradas u ovaladas. Contiene tubos redondos en aluminio, un volante ergonómico con empuñadura giratoria así como un kit para atar la cubierta.

■ **Cover roller for in ground pools.** Unfolds to a maximum length of 5.50 m. Suitable for round, square or oval swimming pools. Includes round anodised aluminium tubes, an ergonomic hand wheel with revolving handle as well as a kit to attach it to the cover.

■ **Enrouleur de bâches pour piscines enterrées.** Il offre un développement maximum de 5,50m. Il convient aux piscines rondes, carrées ou ovales. Il est équipé de tubes ronds en aluminium anodisés, d'un volant ergonomique avec poignée tournante et d'un kit d'attache pour bâche.

■ **Avvolgitore per piscine interrante.** Si srotola fino a un massimo di 5.50m. Adatto per le piscine tonde, quadrate e ovali. Contiene un tubo in alluminio anodizzato, una ghiera ergonomica con una impugnatura rotatoria e un kit per fissare la copertura. Consegnato in un unico imballo.



5,5 m



BXL PACK 1



5,5 m



BXL PACK 1



- **IMPORTANTE:** Estos enrolladores no se pueden colocar en piscinas de composite, existe riesgo de rotura de las playas.
- **IMPORTANT:** These cover rollers can not be placed in any composite pool. There is a risk of breakage.
- **ATTENTION :** Cet enrouleur de bâches ne convient pas pour les piscines en composite. Il existe un risque de rupture des margelles.
- **IMPORTANTE:** Questo avvolgitore non si può installare in piscina in composito, esiste il rischio di rottura dei bordi piscina.



CRP58

■ **Enrollador de piscinas elevadas** para cubiertas de verano hasta 5,8 m de ancho. Tubo telescópico en aluminio. Para piscinas tubulares, de acero y de madera. Fácil instalación.

■ **Basic cover roller for above-ground pools** for summer covers above ground pools up to 5,8 m wide. Telescopic tube in aluminium. For tubular, steel and wooden pools. Easy to install.

■ **Enrouleur pour piscines hors-sol**, pour bâches été pour piscines jusqu'à 5,8 m de largeur. Tubes télescopiques en aluminium. Il s'adapte aussi bien sur les piscines tubulaires que sur les piscines acier et bois. Facile à installer.

■ **Avvolgitore per piscine fuoriterra**, per copertura estive fino a 5,8 m di larghezza. Tubo telescopico in alluminio. Per piscine tubolari, d'acciaio e legno. Facile installazione.

40135

■ **Enrollador piscinas elevadas.** Ofrece un desarrollo máximo de 6 m. Se ata fácilmente a las "playas" de la piscina con 2 placas atornilladas. El uso del enrollador permite una mejor conservación de la cubierta. Incluido: Conectores para piscinas tubulares.

■ **Cover roller for above-ground pools.** Unfolds to a maximum length of 6 m. It can be easily attached to the "edge" finishing pieces of the pool using 2 bolted plates. The use of the cover roller enables a better conservation of the cover. Included: Connectors for tubular pools.

■ **Enrouleur pour piscines hors-sol.** Enrouleur offrant un développement maximum de 6 m. Il se fixe facilement sur les 2 "margelles" de la piscine grâce à ses 2 plaques vissées. Les connecteurs pour piscines tubulaires sont inclus.

■ **Avvolgitore per piscine fuoriterra.** Avvolgitore che si srotola fino a un massimo di 6 m. Si fissa facilmente al "bordo" della piscina con 2 placche con viti. L'utilizzo dell'avvolgitore permette una migliore conservazione della copertura.



5,8 m



6 m



CBX PACK 1



8 412081 306940



CBX PACK 2



8 427370 401350



- PROTECTOR DE PARED
- WALL PROTECTOR
- ROULEAU DE PROTECTION
- PROTEZIONE PER PARETE

772060

■ **Rollo de protección y de drenaje alveolar** de PEAD (polietileno de alta densidad) para piscina de madera (20 x 1,5 m). 1- Pared de piscina de madera 2- Rollo de protección y de drenaje alveolar de PEAD.

■ **Protection and alveolar draining roll** of HDPE (High Density Polyethylene) for wooden pool (20 x 1,5 m). 1- Wood frame 2- Roll of alveolar protection an drainage of HDPE.

■ Pour piscine bois **Rouleau de protection et de drainage alvéolaire** en PEHD (polyéthylène haute densité) (20 x 1,5 m). 1 - Ossature bois 2 - Nappe à excroissances type Delta MS®.

■ **Rotolo di protezione del drenaggio alveolare** di HDPE (polietilene ad alta densità) per piscina in legno (20 x 1,5 m). 1- Struttura in legno 2- Rotolo di protezione del drenaggio alveolare di HDPE.



BXL PACK 1



■ Rollo de protección y de drenaje alveolar de PEHD

■ Protection and alveolar draining roll of HDPE

■ Rouleau de protection et de drainage alvéolaire en PEHD

■ Rotolo di protezione del drenaggio alveolare di HDPE

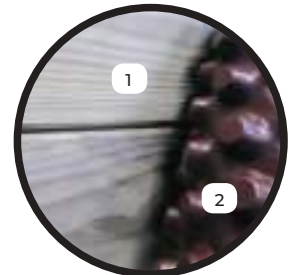
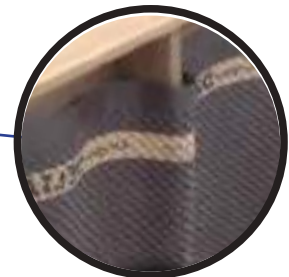

■ Armazón de madera
■ Ossature bois

■ Wood frame
■ Struttura in legno

■ PROTECTORES ■ PROTECTORS ■ PROTECTEURS ■ PROTEZIONE

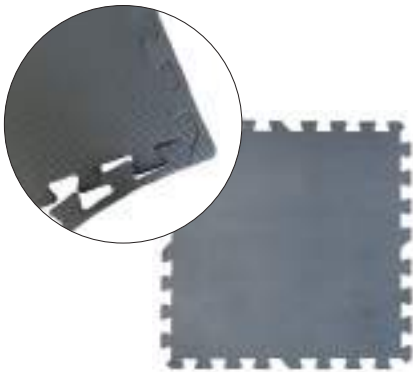

MPF509GY

■ **Protector de suelo de piscina antideslizante.** Material duradero (Etilvinilacetato (EVA)). Ofrece una protección adicional para el fondo de la piscina. 9 piezas.

■ **Non sleppery pool floor protector.** Durable material (Ethylene-vinyl acetate (EVA)). Provides added protection for pool floors. Package contains. 9 pieces.

■ **Protecteur de sol de piscine antidérapant.** Matériau durable (Éthylène-acétate de vinyle (EVA)). Fournit une protection supplémentaire pour le sol des piscines. 9 pièces.

■ **Protezione per il fondo della piscina antiskid.** In materiale resistente (Etilene vinil acetato (EVA)). Evita che il fondo della piscina si danneggi. 9 pezzi.



MPF509GR

■ **Protector de suelo de piscina antideslizante.** Material duradero (Etilvinilacetato (EVA)). Ofrece una protección adicional para el fondo de la piscina. Imitación hierba. 9 piezas.

■ **Non sleppery pool floor protector.** Durable material (Ethylene-vinyl acetate (EVA)). Provides added protection for pool floors. Printed like grass. 9 pieces.

■ **Protecteur de sol de piscine antidérapant.** Matériau durable (Éthylène-acétate de vinyle (EVA)). Fournit une protection supplémentaire pour le sol des piscines. Imitation herbe. 9 pièces.

■ **Protezione per il fondo della piscina antiskid.** In materiale resistente (Etilene vinil acetato (EVA)). Evita che il fondo della piscina si danneggi. Erba artificiale. 9 pezzi.

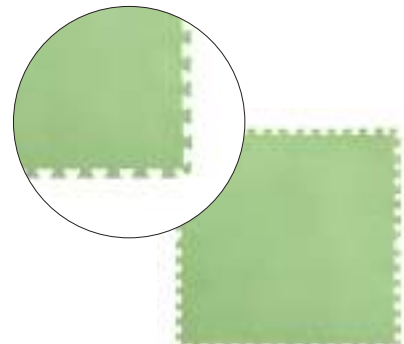

MPF819

■ **Protector de suelo de piscina.** Material duradero (Etilvinilacetato (EVA)). Ofrece una protección adicional para el fondo de la piscina. 9 piezas.

■ **Pool floor protector.** Durable material (Ethylene-vinyl acetate (EVA)). Provides added protection for pool floors. 9 pieces.

■ **Protecteur de sol de piscine.** Matériau durable (Éthylène-acétate de vinyle (EVA)). Fournit une protection supplémentaire pour le sol des piscines. 9 pièces.

■ **Protezione per il fondo della piscina.** In materiale resistente (Etilene vinil acetato (EVA)). Evita che il fondo della piscina si danneggi. 9 pezzi.

	50x50cm = 2,25m ²
	8 mm
	PB PACK 8
	 8 412081 302638

	50x50cm = 2,25m ²
	8 mm
	PB PACK 8
	 8 412081 268521

	81x81cm = 5,90m ²
	4,5 mm
	PB PACK 7
	 8 412081 268361





MPF509P

■ **Protector de suelo de piscina antideslizante.** Material duradero (Etilvinilacetato (EVA)). Ofrece una protección adicional para el fondo de la piscina. 9 piezas.

■ **Non sleppery pool floor protector.** Durable material (Ethylene-vinyl acetate (EVA)). Provides added protection for pool floors. 9 pieces.

■ **Protecteur de sol de piscine antidérapant.** Matériau durable (Éthylène-acétate de vinyle (EVA)). Fournit une protection supplémentaire pour le sol des piscines. 9 pièces.

■ **Protezione per il fondo della piscina antiskid.** In materiale resistente (Etilene vinil acetato (EVA)). Evita che il fondo della piscina si danneggi. 9 pezzi.

MPF509

■ **Protector de suelo de piscina.** Material duradero (Etilvinilacetato (EVA)). Ofrece una protección adicional para el fondo de la piscina. 9 piezas.

■ **Pool floor protector.** Durable material (Ethylene-vinyl acetate (EVA)). Provides added protection for pool floors. 9 pieces.

■ **Protecteur de sol de piscine.** Matériau durable (Éthylène-acétate de vinyle (EVA)). Fournit une protection supplémentaire pour le sol des piscines. 9 pièces.

■ **Protezione per il fondo della piscina.** In materiale resistente (Etilene vinil acetato (EVA)). Evita che il fondo della piscina si danneggi. 9 pezzi.



MPF509BOX60



■ **Box protector de suelo de piscina.** Material duradero (Etilvinilacetato (EVA)). Ofrece una protección adicional para el fondo de la piscina. 9 piezas.

■ **Pool floor protector.** Durable material (Ethylene-vinyl acetate (EVA)). Provides added protection for pool floors. 9 pieces.

■ **Protecteur de sol de piscine.** Matériau durable (Éthylène-acétate de vinyle (EVA)). Fournit une protection supplémentaire pour le sol des piscines. 9 pièces.

■ **Protezione per il fondo della piscina.** In materiale resistente (Etilene vinil acetato (EVA)). Evita che il fondo della piscina si danneggi. 9 pezzi.

	50x50cm = 2,25m ²
	8 mm
	PB PACK 8
	 8 412081 304922

	50x50cm = 2,25m ²
	4,5 mm
	PB PACK 14
	 8 412081 252001

	50x50cm = 2,25m ²
	4,5 mm
	PB PACK 60
	 8 412081 258980



■ LINERS PARA PISCINA DE MADERA
 ■ WOODEN POOL LINERS
 ■ LINERS POUR PISCINES BOIS
 ■ LINERS PER PISCINE IN LEGNO



■ Cambiar el liner de una piscina de madera
 ■ Change the liner in a wooden pool
 ■ Changer le liner d'une piscine en bois
 ■ Sostituzione del liner in una piscina in legno

- Sistema beaded
- Beaded system
- Système d'accrochage Hung
- Sistema beaded

- Liner azul
- Blue liner
- Liner bleu
- Liner blu

- Liner beige
- Beige liner
- Liner beige
- Liner beige

(BD)



F790207		75/100		BRAGA 790207	
786334		75/100	VERMELA 790098		
786217		75/100	VERMELA 790098		
F800007		75/100	ORANGE 800007		
F790206		75/100		EVORA 790206	
F7900892		75/100	SAFRAN 2 7900892		
783809		75/100	SAFRAN 790089		
786216		75/100	SAFRAN 790089		
F7900872		60/100	CANELLE 2 7900872		
778768		60/100	CANELLE 790087		
786215		60/100	CANELLE 790087		

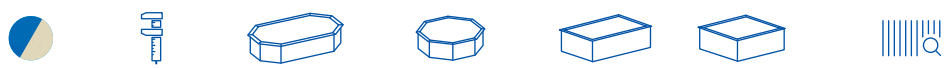

F790053C		60/100	CAMOMILLE 790202				3
F790203		75/100	AVOCADO 790203				8
F790204		50/100			LEMON 790204		8
F800003		75/100		VIOLETTE 2 800003			8
783885		75/100		VIOLETTE 790085			3
786214		75/100		VIOLETTE 790085			3
F790302		75/100		VASTO 790302			8
F7900862		60/100	GRENADE 2 7900862				8
778767		60/100	GRENADE 790086				3
F790210		75/100		ANANAS 790210			8
F7900962		75/100			MARBELLA 2 7900962		8
785945		75/100			MARBELLA 790096		3
786213		50/100		VANILLE 790083			3
F790208		75/100	SEVILLA 790208				8
F790205		60/100			CARRA 790205		8
F800002		50/100		VANILLE 2 800002			8
778689		50/100		VANILLE 790083			3
788045		50/100			CITY 790000		3
F800008		50/100		LILI 2 800008			8
F800009		75/100			EVORA PLUS 800009		8
785943		75/100			BRAGA 790095		3
785939		75/100			EVORA 790094		3
785949		60/100			MANGO KPBR620		3
785951		60/100	MACADAMIA KPBOC632				3
785950		60/100	BAMBÚ KPBOC535				3























■ LINERS PARA PISCINA DE COMPOSITE
 ■ COMPOSITE POOL LINERS
 ■ LINERS POUR PISCINES COMPOSITE
 ■ LINERS PER PISCINE COMPOSITE



(BD)

- Sistema beaded
- Beaded system
- Système d'accrochage Hung
- Sistema beaded

- Liner gris
- Grey liner
- Liner gris
- Liner grigio

						
SPCO80G		804 x 386 cm	124 cm	60/100	BD	 8 4 12081 267234
SPCO66G		664 x 386 cm	124 cm	60/100	BD	 8 4 12081 267227
SPCO6650G		664 x 386 cm	154 cm	60/100	BD	 8 4 12081 315591
SPCO52G		524 x 386 cm	124 cm	60/100	BD	 8 4 12081 267210
SPCOR60G		606 x 326 cm	124 cm	60/100	BD	 8 4 12081 267197
SPCOR46G		466 x 326 cm	124 cm	60/100	BD	 3 612820 002200
SPCO41G		Ø 410 cm	124 cm	60/100	BD	 8 4 12081 267203
SPCOR28G		326 x 326 cm	96 cm	60/100	BD	 8 4 12081 267180
SPCOR2814G		326 x 186 cm	96 cm	60/100	BD	 3 612820 002477

- LINERS PARA PISCINA DE ACERO
- STEEL WALL POOL LINERS
- LINERS POUR PISCINES PAROI ACIER
- LINERS PER PISCINE CON PARETI IN ACCIAIO



- Montaje del liner de una piscina de acero
- Steel pool liner installation
- Installation d'un liner de piscine en acier
- Installazione di un liner per piscina in acciaio



- Liner azul
- Blue liner
- Liner bleu
- Liner blu

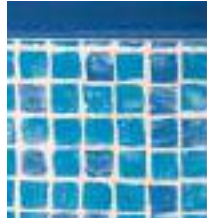

- Liner gresite
- Ceramics liner
- Liner carrelage
- Liner mosaicato



- (SC)
- Sistema colgante
 - Hanging system
 - Système d'accroche
 - Con barra di agganciamento



- (BD*)
- Sistema beaded
 - Beaded system
 - Système d'accrochage Hung
 - Sistema beaded



- (OV)
- Sistema overlap
 - Overlap system
 - Système à recouvrement
 - Sistema overlap



Model	Color	Dimensions (L x W)	Height	Bracket	System	Barcode
FPROV1028	Blue	1000 x 550 cm	132 cm	40/100	SC	8 4 12081 224 169
FPROV917	Ceramic	915 x 470 cm	132 cm	50/100	SC	8 4 12081 258 195
FPROV918	Blue	915 x 470 cm	132 cm	40/100	SC	8 4 12081 214 511
FPROV915	Blue	915 x 470 cm	120 cm	40/100	SC	8 4 12081 980 270
FPROV827	Ceramic	800 x 470 cm	132 cm	50/100	SC	8 4 12081 258 201
FPROV818	Blue	800 x 470 cm	132 cm	40/100	SC	8 4 12081 224 091
FPROV810	Blue	800 x 470 cm	120 cm	40/100	SC	8 4 12081 206 059
PROV8012FE*	Blue	800 x 400 cm	150 cm	75/100	BD	8 4 20382 775 976
PROV8013FE*	Blue	800 x 400 cm	120 cm	60/100	BD	8 4 12081 274 249
FPROV737	Ceramic	730 x 375 cm	132 cm	50/100	SC	8 4 12081 258 218
FPROV738	Blue	730 x 375 cm	132 cm	40/100	SC	8 4 12081 224 107
FPROV730	Blue	730 x 375 cm	120 cm	40/100	SC	8 4 12081 980 287
FSPROV730	Blue	730 x 375 cm	120 cm	40/100	OV	8 4 12081 237 879
770399	Blue	730 x 375 cm	120 cm	75/100	OV	3 605217 703996
PROV7012FE*	Blue	700 x 320 cm	150 cm	75/100	BD	8 4 20382 775 969
PROV7013FE*	Blue	700 x 320 cm	120 cm	60/100	BD	8 4 12081 274 225
FPROV617	Ceramic	610 x 375 cm	132 cm	50/100	SC	8 4 12081 258 225
FPROV618	Blue	610 x 375 cm	132 cm	40/100	SC	8 4 12081 224 114

* Solo para piscinas enterradas ■ Only for inground pools ■ Uniquement pour piscines enterrées ■ Solo per piscine interrata

















■ complementos ■ complements ■ complements ■ complementi

						
FPROV610		610 x 375 cm	120 cm	40/100	SC	8 4 12081 206066
FSPROV610		610 x 375 cm	120 cm	40/100	OV	8 4 12081 237824
773486		610 x 370 cm	120 cm	75/100	OV	3 605217 734860
PROV6012FE*		600 x 320 cm	150 cm	75/100	BD	8 420382 775952
PROV6013FE*		600 x 320 cm	120 cm	60/100	BD	8 420382 775921
PROV5112FE*		500 x 300 cm	150 cm	75/100	BD	8 4 12081 247632
FPROV517		500 x 300 cm	132 cm	50/100	SC	8 4 12081 258232
PROV5113FE*		500 x 300 cm	120 cm	60/100	BD	8 4 12081 247731
FPROV500		500 x 300 cm	120 cm	40/100	SC	8 4 12081 221878
FSPROV500		500 x 300 cm	120 cm	30/100	OV	8 4 12081 237831

* ■ Solo para piscinas enterradas ■ Only for inground pools ■ Uniquement pour piscines enterrées ■ Solo per piscine interrata

						
FPROV707		700 x 450 cm	120 cm	40/100	SC	8 4 12081 204338
FPROV627		625 x 375 cm	120 cm	40/100	SC	8 4 12081 204345
FPROV507		500 x 340 cm	120 cm	40/100	SC	8 4 12081 204352

						
FPR557		ø 550 cm	132 cm	50/100	SC	8 4 12081 258249
FPR558		ø 550 cm	132 cm	40/100	SC	8 4 12081 214504
FPR551		ø 550 cm	120 cm	40/100	SC	8 4 12081 950648
PR5513FE*		ø 550 cm	120 cm	60/100	BD	8 4 12081 248127
770398		ø 460 cm	120 cm	75/100	OV	3 605217 703989
FPR457		ø 460 cm	132 cm	50/100	SC	8 4 12081 258256
FPR458		ø 460 cm	132 cm	40/100	SC	8 4 12081 224121
FPR451		ø 460 cm	120 cm	40/100	SC	8 4 12081 980485
PR4212FE*		ø 420 cm	150 cm	75/100	BD	8 4 12081 274256
PR4213FE*		ø 420 cm	120 cm	60/100	BD	8 420382 775983

						
FSPR460		ø 460 cm	120 cm	30/100	OV	8 412081 237848
FSP450		ø 450 cm	90 cm	20/100	OV	8 412081 990217
FSP400		ø 400 cm	90 cm	20/100	OV	8 412081 990224
FPR357		ø 350 cm	132 cm	50/100	SC	8 412081 258263
PR3513FE*		ø 350 cm	120 cm	60/100	BD	8 412081 247717
FPR358		ø 350 cm	132 cm	40/100	SC	8 412081 233918
FPR352		ø 350 cm	120 cm	40/100	SC	8 412081 200576
FPR354		ø 350 cm	90 cm	30/100	SC	8 412081 201177
FSPR350		ø 350 cm	120 cm	30/100	OV	8 412081 237855
FSP350		ø 350 cm	90 cm	20/100	OV	8 412081 990231
FPR301		ø 300 cm	120 cm	40/100	SC	8 412081 216027
PR3013FE*		ø 300 cm	120 cm	60/100	BD	8 412081 315287
FSP300		ø 300 cm	90 cm	20/100	OV	8 412081 203249
FWPR30		ø 300 cm	65 cm	20/100	OV	8 412081 201191
FPR241		ø 240 cm	120 cm	40/100	SC	8 412081 203010

* ■ Solo para piscinas enterradas ■ Only for inground pools ■ Uniquement pour piscines enterrées ■ Solo per piscine interrata

■ REPARADORES DE LINER
 ■ LINER REPAIR
 ■ RÉPARATION LINER
 ■ RIPARAZIONE LINER



- Cómo colocar un parche reparador
- How to apply a repair film
- Comment appliquer un film de réparation
- Come applicare una pellicola di riparazione



40080



V12



AR202



BL PACK 24 DIS



8 427370 400803



BL PACK 50



8 412081 870236



BL PACK 96



8 412081 960203

- Kit reparación liner
- Liner repair kit
- Kit de réparation pour liner
- Kit riparazione liner

- Kit reparador de PVC
- PVC repair kit
- Kit de réparation PVC
- Kit per riparazioni PVC

- Film reparador de PVC
- PVC repair film
- Film de réparation PVC
- Pellicola per riparare i liner

■ ESCALERAS PARA PISCINA ENTERRADA ■ INGROUND POOL LADDERS
 ■ ÉCHELLES POUR PISCINES ENTERRÉES ■ SCALETTA PER PISCINA INTERRATA



EIE30

■ Escalera de 3 peldaños de seguridad con doble superficie antideslizante que garantiza mayor seguridad. Apto para piscinas enterradas. Permite un acceso más fácil y seguro.

■ 3 step safety stairs with double anti-slip surface guaranteeing greater safety. Apt for above in-ground pools. Allows easier and safer access.

■ Échelle de 3 marches de sécurité avec double surface antidérapante qui garantit une plus grande sécurité. Apte pour piscines enterrées. Permet un accès plus facile et sûr.

■ Scaletta a 3 gradini di sicurezza con doppia superficie antiscivolo che garantisce maggiore sicurezza. Adatta per piscine interrate. Consente un accesso più rapido e sicuro.



EPE30

■ Escalera sintética para piscinas enterradas. 4 peldaños. Material: polietileno de alta densidad HDPE. Se debe rellenar con arena (aprox. 23 kg).

■ Easy access synthetic ladder for in ground pools. 4 steps. Material: High Density Polyethylene HDPE. Must be filled with sand (approx. 23 kg).

■ Échelle synthétique d'entrée facile pour piscine enterrée. 4 marches. Matériau: polyéthylène de haute densité HDPE. Doit être rempli avec du sable (environ 23 kg).

■ Scaletta sintetica per piscina interrata. 4 gradini. Materiale: Polietilene ad alta densità HDPE. Deve essere riempito con sabbia (circa 23 kg).

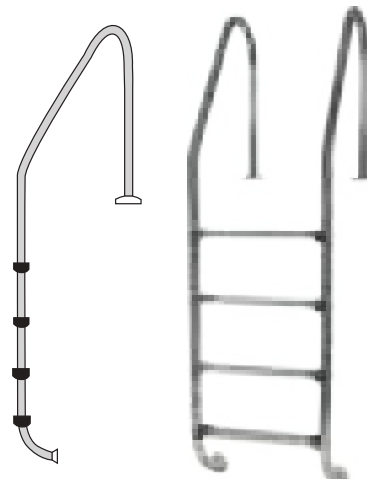

40272

■ Escalera STANDARD para piscina enterrada de 4 peldaños Inox. Peldaños antideslizantes para mayor seguridad y prevenir accidentes.

■ Stainless steel STANDARD inground pool ladder - 4 steps. Anti-slip steps for greater safety and prevent accidents.

■ Échelle modèle STANDARD acier inoxydable pour piscine enterrée - 4 marches. Marches antidérapantes pour conférer une plus grande sécurité et prévenir les accidents.

■ Scaletta STANDARD per piscina interrata da 4 gradini - Inox. Piedini antiscivolo per maggiore sicurezza e prevenire incidenti.



BXL PACK 1



8 412081 268514



BXL PACK 1



8 412081 268507



BXL PACK 1



8 412081 250762



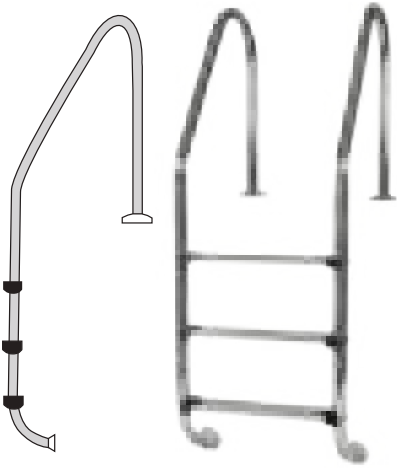

40110

- Escalera STANDARD para piscina enterrada de 3 peldaños Inox. Peldaños antideslizantes para mayor seguridad y prevenir accidentes.
- Stainless steel STANDARD inground pool ladder - 3 steps. Anti-slip steps for greater safety and prevent accidents.
- Échelle modèle STANDARD acier inoxydable pour piscine enterrée - 3 marches. Marches antidérapantes pour conférer une plus grande sécurité et prévenir les accidents.
- Scaletta STANDARD per piscina interrata da 3 gradini - Inox. Piedini antiscivolo per maggiore sicurezza e prevenire incidenti.



40274

- Escalera MURO para piscina enterrada de 4 peldaños Inox. Peldaños antideslizantes para mayor seguridad y prevenir accidentes.
- Stainless steel inground pool WALL ladder - 4 steps Anti-slip steps for greater safety and prevent accidents.
- Échelle modèle MURALE acier inoxydable pour piscine enterrée - 4 marches. Marches antidérapantes pour conférer une plus grande sécurité et prévenir les accidents.
- Scaletta MURO per piscina interrata da 4 gradini - Inox. Piedini antiscivolo per maggiore sicurezza e prevenire incidenti.



40273

- Escalera MURO para piscina enterrada de 3 peldaños Inox. Peldaños antideslizantes para mayor seguridad y prevenir accidentes.
- Stainless steel inground pool WALL ladder - 3 steps. Anti-slip steps for greater safety and prevent accidents.
- Échelle modèle MURALE acier inoxydable pour piscine enterrée - 3 marches. Marches antidérapantes pour conférer une plus grande sécurité et prévenir les accidents.
- Scaletta MURO per piscina interrata da 3 gradini - Inox. Piedini antiscivolo per maggiore sicurezza e prevenire incidenti.



BXL PACK 1



8 427370 401107



BXL PACK 1



8 412081 250779



BXL PACK 1



8 412081 250786



■ complementos ■ complements ■ complements ■ complementi

■ ESCALERAS PARA PISCINA SOBRE SUELO ■ ABOVE-GROUND POOL LADDERS
 ■ ÉCHELLES POUR PISCINES HORS SOL ■ SCALETTA PER PISCINA FUORI TERRA



L4PL

■ **Escalera moldeada por soplado.** Escalera de seguridad tipo tijera con plataforma - 2x4 peldaños antideslizantes que reducen el riesgo de accidentes.

■ **Blow molded ladder.** Safety scissor type stairs with platform. 2x4 non-slip steps. Reduce risk of accidents.

■ **Échelle moulée par soufflage.** Échelle de sécurité de type ciseaux avec plateforme. 2x4 marches antidérapantes. Réduisent le risque d'accidents.

■ **Scaletta stampata a soffiaggio.** Scala di sicurezza tipo forbice con piattaforma. Scala esterna estraibile per maggiore sicurezza.



ES1213

■ **Escalera de seguridad 2x3 peldaños + plataforma.** Peldaños antideslizantes que reducen el riesgo de accidentes. Escalera exterior extraíble para más seguridad.

■ **Safety ladder 2x3 steps + platform.** Non-slip steps. Reduce risk of accidents. Removable exterior stepladder for greater safety

■ **Échelle sécurité 2x3 marches + plateforme.** Marches antidérapantes. Réduisent le risque d'accidents. Échelle extérieure extractible pour plus de sécurité

■ **Scala di sicurezza 2x3 gradini + piattaforma.** Gradini antiscivolo. Riducono il rischio di incident. Scala esterna estraibile per maggiore sicurezza



- Montaje
- Assembly
- Montage
- Montaggio



ET1213

■ **Escalera 2x3 peldaños + plataforma.** Peldaños antideslizantes que reducen el riesgo de accidentes.

■ **Ladder 2x3 steps + platform.** Non-slip steps. Reduce risk of accidents.

■ **Échelle 134cm 2x3 marches + plateforme.** Marches antidérapantes. Réduisent le risque d'accidents.

■ **Scala 2x3 gradini + piattaforma.** Gradini antiscivolo. Riducono il rischio di incident.



- Montaje
- Assembly
- Montage
- Montaggio



BXL PACK 1



BXL PACK 1



BXL PACK 1





ART1680

■ **Escalera de acero inoxidable tipo tijera** para piscinas desmontables 2x4 peldaños + plataforma. Peldaños antideslizantes para una mayor seguridad.

■ **Stainless steel scissor type stairs** for dismountable pools 2x4 steps + platform. Anti-slip steps for greater safety.

■ **Échelle en acier inoxydable de type ciseaux** pour piscines démontables 2x4 marches + plateforme. Marches antidérapantes pour une plus grande sécurité.

■ **Scala in acciaio inox tipo forbice** per piscine smontabili 2x4 gradini + piattaforma. Gradini antiscivolo per una maggiore sicurezza.



AR109

■ **Escalera de acero tipo tijera.** 2x2 peldaños con sistema antideslizante. Pies con topes de goma que dan estabilidad y evitan estropear el liner.

■ **Steel scissor type stairs.** 2x2 non-slip steps. Reduce risk of accidents. Feet with rubber stops giving stability and avoid breaking the liner.

■ **Échelle en acier de type ciseaux.** 2x2 marches antidérapantes. Réduisent le risque d'accidents. Pieds avec cales en caoutchouc qui apportent de la stabilité et évitent d'abimer le liner.

■ **Scala in acciaio tipo forbice.** 2x2 gradini antiscivolo. Riducono il rischio di incidenti. Piedini con rivestimento in gomma che danno stabilità evitando la rottura del liner.



SPAL2

■ **Escalera sintética de 2 peldaños** para facilitar el acceso al Spa. Peldaños antideslizantes para mayor seguridad.

■ **2-step synthetic ladder** for easy access to the Spa. Anti-slip steps for greater safety and prevent accidents.

■ **Échelle synthétique à 2 marches** pour un accès facile au spa. Marches antidérapantes pour conférer une plus grande sécurité et prévenir les accidents.

■ **Scala sintetica con 2 gradini** per un facile accesso alla vasca spa. Piedini antiscivolo per maggiore sicurezza e prevenire incidenti.



H. 142 cm



BXL PACK 1



8 412081 231082



H. 98 cm



BXL PACK 1



8 412081 980522



70 x 65 x 34 cm



BXL PACK 1



8 412081 302935



■ complementos ■ complements ■ complements ■ complementi

- ESCALERA PARA PISCINA DE MADERA
- WOODEN POOL LADDER
- ECHELLES POUR PISCINES BOIS
- SCALETTA PER PISCINE IN LEGNO



126674

■ **Escalera de acero inoxidable partida 3 peldaños antideslizantes.** Peldaños antideslizantes para mayor seguridad y prevenir accidentes. Para piscinas de madera .

■ **Split stainless steel ladder 3 non-slip steps.** Anti-slip steps for greater safety and prevent accidents. For wooden pools.

■ **Échelle en acier inoxydable à 2 éléments.** 3 marches antidérapantes. Marches antidérapantes pour conférer une plus grande sécurité et prévenir les accidents. Pour piscines en bois.

■ **Scaletta in acciaio inox a due elementi.** 3 gradini antiscivolo. Piedini antiscivolo per maggiore sicurezza e prevenire incidenti. Per piscine in legno.

- DEPORTE EN LA PISCINA
- POOL FITNESS
- FITNESS PISCINE
- FITNESS IN PISCINA



AQB2

■ **Bicicleta acuática - Aquabike.** Una nueva forma de hacer ejercicio en bicicleta cuando estás en la piscina. Concebido para todo tipo de piscinas. Sillín anatómico - Manillar deportivo - Ruedas antiarañazos - Pedales anatómicos con resistencia ajustable.

■ **Aquabike.** A new way of exercising by cycling when you are in the pool. Conceived for all type of pools. Anatomic saddle - Sporting handle bar - Anti scratch wheels- Anatomic pedals with adjustable resistance.

■ **Vélo de piscine.** Une nouvelle façon de faire de l'exercice à vélo lorsque vous êtes dans la piscine. Conçu pour tous les types de piscine. Selle anatomique - guidon sportif - roues anti-rayures pour un transport facile - Pédales anatomiques avec résistance réglable.

■ **Bicicletta acquatica.** Un nuovo modo di allenarsi in bici quando si è in piscina. Progettato per tutti i tipi di piscine. Sellino anatomico - manubrio sportivo - ruote antigraffio per facilitare il trasporto - Pedali anatomici con resistenza regolabile.



CBX PACK 1



8 412081 266749



CBX PACK 1



8 412081 303475



■ SEGURIDAD PARA LA PISCINA ■ POOL SECURITY
 ■ EQUIPEMENTS DE SÉCURITÉ POUR PISCINE ■ PROTEZIONE PER PISCINE



SF133

■ **Barrera de protección para piscinas.** Módulo pre-montado. Longitud y forma adaptable a la piscina.. Módulo de 3 m de uso individual. Altura de la barrera: 1,33 m. Tejido efecto transparente que permite una visibilidad excelente de la piscina.

■ **Safety fence for swimming pool.** Ready to install. Adjustable in length to answer all configurations. 3 m module for individual use. Fence height : 1,33 m. Transparent net witch allows an excellent visibility of the swimming pool. Norm: NF P 90-306.

■ **Barrière de protection pour piscine.** Module pré-monté. Adaptable en longueur pour répondre à toutes les configurations. Module de 3 m à usage individuel. Hauteur de la barrière : 1,33 m. Toile effet «transparent» qui permet une excellente visibilité du bassin. Conforme à la norme NF P 90-306.

■ **Barriera di protezione per piscine.** Modulo pre installato. Lunghezza adattabile in base alle forme della piscina. Modulo di 3 m ad uso individuale. Altezza della barriera: 1,33 m. Tessuto effetto trasparente che permetta una visibilità eccellente della vasca.



770270

■ **Alarma de piscina.** Vigilancia máxima. Detector de inmersión certificado DE CONFORMIDAD con la norma NF P90 307/A1 por el LNE. Sin activación imprevista. Se coloca en modo vigilancia automática 15 minutos después del baño. Información permanente sobre el estado de la vigilancia.

■ **Pool alarm.** Maximum surveillance. Immersion detector with CONFORMITY certificate with the NF P90 307/A1 Standard by LNE. Without unexpected activation. Automatically enters into surveillance mode 15 minutes after the last use of the pool. Permanent information about the surveillance status.

■ **Alarme de piscine.** Surveillance maxi. Détecteur d'immersion certifié CONFORME à la norme NF P90 307/A1 par le LNE. Aucun déclenchement intempestif. emise en surveillance maximale 15 minutes après la baignade. Information permanente sur l'état de surveillance.

■ **Allarme per piscina.** Massimo livello di vigilanza. Rilevatore di immersione certificato IN CONFORMITÀ con la normativa NF P90 307/A1 dell'LNE. Senza attivazione imprevista. Si posiziona in modalità di vigilanza automatica 15 minuti dopo l'utilizzo della piscina. Informazione permanente sullo stato di vigilanza.



CBX PACK 1



8 412081 308159



CBX PACK 1



3 605217 702708



■ **FILTROS DE ARENA ■ SAND FILTERS**
 ■ **FILTRE A SABLE ■ FILTRO A SABBIA**

■ Las impurezas quedan retenidas en el medio filtrante del interior de la cuba. Son muy compactos, fáciles de instalar, utilizar y no requieren especial atención. Gracias a su válvula selectora (5/6 vías dependiendo del modelo), permiten realizar diferentes funciones: autolimpiado, filtración, vaciado... Los filtros FA6100 / FS550 / FS500 / FS400 / FS320 incorporan un prefiltro para retener las partículas excesivamente grandes y evitar dañar la bomba. Además, están certificados con la norma europea EN 16713-1:2015 que garantiza que cumple con las normativas de seguridad establecidas.

■ Impurities are held by the filter media inside the tank. Sand filters are compact sized, easy to install and use and special care is not required. Thanks to their multiport valves (5/6 ways depending on the version), different functions can be carried out: self-cleaning, filtration, emptying... Filters FA6100 / FS550 / FS500 / FS400 / FS320 are certified with the standard europe EN 16713-1:2015 ensuring that they comply with the safety regulations set. They include a prefilter to hold the largest particles to prevent pump from any damage.

■ Les impuretés sont retenues dans le média filtrant à l'intérieur de la cuve. Ces filtres sont très compacts et très faciles à installer et à utiliser. Ils ne nécessitent pas d'attention particulière. Sa vanne multivoie (5/6 voies, suivant le modèle), permet de réaliser diverses fonctions: auto nettoyage, filtrage, vidange... Les filtres FA6100 / FS550 / FS500 / FS400 / FS320 sont certifiés par la norme européenne EN 16713-1:2015 garantissant qu'ils respectent les réglementations établies en matière de sécurité. Le filtre est muni d'un pré filtre qui retient les particules excessivement grandes pour éviter d'endommager la pompe.

■ Le impurità rimangono intrappolate nelle carico filtrante all'interno del cestello. Sono molto compatti, facili da installare e da utilizzare e non richiedono cure particolari. . Grazie alla valvola selettiva della quale sono dotati (5/6/7 uscite a seconda del modello), consentono diverse funzioni: autopulizia, filtrazione, svuotamento... Il filtri FA6100 / FS550 / FS500 / FS400 / FS320 sono certificati dalla normativa europea EN 16713-1:2015 che garantisce la loro conformità alle normative di sicurezza vigenti. Sono composti da un prefiltro per trattenere le particelle eccessivamente grandi ed evitare il danneggiamento della pompa.

- Filtro independiente soplado top
- Independent top blow molded filters
- Filtre à sable soufflé en vanne top
- Filtro soffiato top con valvola superiore



REF. FIS600



REF. FIS500



REF. FIS400



FIS600	Ø 600 mm	±150 kg	6	CBX PACK 1	8 4 12081 305011
FIS500	Ø 500 mm	±85 kg	6	CBX PACK 1	8 4 12081 305004
FIS400	Ø 400 mm	±40 kg	6	CBX PACK 1	8 4 12081 304991

- Kits de filtración ■ Filtration kits
- Kits de filtration ■ Kit di filtrazione



- Cómo instalar una depuradora de arena
- How to install a sand filter
- Comment installer un filtre a sable
- Come installare un filtro a sabbia



REF. FA6100



REF. FS500



REF. FS550



REF. FS400



REF. FS320



REF. FS320NP
No prefilter



HP



	Ø	Flow	Power	HP	Weight	Parts	Packaging	Barcode
FA6100	600 mm	10.000 l/h	485 W	0,66 CV/HP	±130 kg	6	BXL PACK 1	8 4 12081 233857
FS550	500 mm	10.000 l/h	800 W	1 CV/HP	±85 kg	6	CBX PACK 1	8 4 12081 307053
FS500	500 mm	8.000 l/h	550 W	0,75 CV/HP	±85 kg	5	CBX PACK 1	8 4 12081 252339
FS400	400 mm	6.000 l/h	230 W	0,31 CV/HP	±40 kg	5	CBX PACK 1	8 4 12081 252322
FS320	320 mm	4.000 l/h	180 W	0,24 CV/HP	±20 kg	5	CBX PACK 1	8 4 12081 303406
FS320NP	320 mm	4.000 l/h	180 W	0,24 CV/HP	±20 kg	5	CBX PACK 1	8 4 12081 308906



■ BOMBAS ■ PUMPS
■ POMPES DE FILTRATION ■ POMPE

■ Gama de bombas autoaspirantes GRE con potencias comprendidas entre 1/3 CV y 2 CV. Se trata de bombas centrifugas de una sola etapa, autocebantes, concebidas para uso con un sistema de filtración de piscina.

■ The self-priming pump range GRE emits power between 1/3 CV and 2 CV. Centrifugal pumps are single stage, self-priming pumps designed for use in a swimming pool filtration systems.

■ Gamme de pompes auto-aspirantes de la marque GRE, avec des puissances comprises entre 1/3 CV et 2 CV. Il s'agit de pompes centrifuges, auto-amorçantes, conçues pour une utilisation avec un système de filtration de piscine.

■ Gamma di pompe autoaspiranti GRE con potenze comprese tra 1/3 CV e 2 CV. Si tratta di pompe centrifughe monostadio, autoadescanti, concepite per l'uso con un sistema di filtrazione per piscina.

PREMIUM

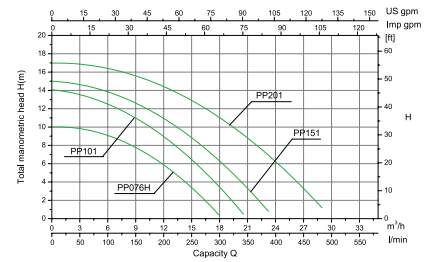

- Curvas de rendimiento hidráulico
- Hydraulic performance curves
- Courbes de performances hydrauliques
- Curve delle prestazioni idrauliche

COMFORT

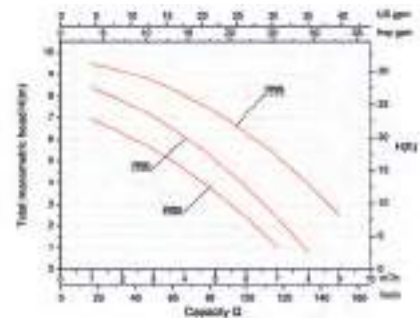

HP



PREMIUM

PP202	∅ 800 mm	27.000 l/h	1600 W	2 CV/HP	170 m ³	CBX PACK 1	8 412081 289632
PP152	∅ 700 mm	22.000 l/h	1100 W	1,5 CV/HP	135 m ³	CBX PACK 1	8 412081 289625
PP102	∅ 600 mm	20.000 l/h	900 W	1 CV/HP	100 m ³	CBX PACK 1	8 412081 289618
PP077H	∅ 500 mm	17.000 l/h	600 W	3/4 CV/HP	65 m ³	CBX PACK 1	8 412081 289601

COMFORT

PP077	∅ 500 mm	9.500 l/h	550 W	3/4 CV/HP	65 m ³	CBX PACK 1	8 412081 289595
PP052	∅ 400 mm	8.500 l/h	450 W	1/2 CV/HP	50 m ³	CBX PACK 1	8 412081 289588
PP032	∅ 300 mm	7.000 l/h	250 W	1/3 CV/HP	35 m ³	CBX PACK 1	8 412081 289571



NEW
2024

VSG75

■ **Bomba de velocidad variable** que incluye un inversor integrado y un controlador inteligente con función de temporizador y gestión de la velocidad. Permite la circulación de piscinas enterradas de hasta 65 m³. Bomba de 0,75 CV.

■ **Variable speed pump** that includes an integrated inverter and an intelligent controller with timer function and speed management. Allows circulation ground pools up to 65 m³. 0,75 HP pump.

■ **Pompe à vitesse variable** Pompe à vitesse variable comprenant un inverseur intégré et un contrôleur intelligent avec fonction de minuterie et gestion de la vitesse. Permet la circulation de piscines enterrées jusqu'à 65 m³. Pompe de 0,75 CV.

■ **Pompa a velocità variabile** che include un inverter integrato e un controller intelligente con funzione timer e gestione della velocità. Consente la circolazione di piscine a terra fino a 65 m³. Pompa da 0,75 HP.



CBX PACK 1



■ FILTROS AQUALOON ■ AQUALOON FILTERS ■ FILTRE A AQUALOON ■ FILTRO A AQUALOON

■ Son muchas las ventajas de este medio filtrante: Ahorro de energía · Gran capacidad para atrapar la suciedad · Evita obstrucciones · Resultado eficaz y excelente de la filtración · Menor frecuencia de lavado · Producto de larga vida · Fácil de eliminar, no es tóxico · Bajo peso para un fácil manejo · Polietileno 100% reciclable

■ Ce milieu filtrant présente de nombreux avantages : Filtre n'importe quel résidu jusqu'à 3 microns - Économie d'énergie - Grande capacité pour retenir la saleté - Évite les obstructions - Un résultat efficace et excellent de la filtration - Diminution de la fréquence de lavage - Longue durée de vie - Facile à jeter, n'est pas toxique - Faible poids pour une meilleure manipulation - Polyéthylène 100% recyclable.

■ There are many advantages of this filter medium: Energy saving · High dirt capacity · No clogging · Excellent filtration result and efficiency · Lowest back wash frequency · Long life product · Easy disposal, non toxic · Low weight for easy handling · Polyethylene 100% recyclable

■ I vantaggi di questo mezzo filtrante sono molteplici: Filtra qualsiasi residuo fino a 3 micron · Risparmio di energia · Grande capacità di catturare lo sporco · Evita le ostruzioni · Ne risulta una filtrazione efficiente ed eccellente · Minore frequenza di lavaggio · Prodotto a lunga durata · Semplice da smaltire, non tossico · Facile da maneggiare grazie al peso contenuto · Polietilene riciclabile al 100%.



- Aqualoon, el filtro de piscina ecológico
- Aqualoon, the environmentally friendly pool filter
- Aqualoon, le filtre de piscine écologique
- Aqualoon, il filtro ecologico per piscine

NEW
2024



FAQC40

■ **Filtro Aqualoon.** Para piscinas hasta 15m³. Tanque 10,5 l. Caudal: 3,8 m³/h. Conexiones 32 y 38 mm. Incluye 256 g de Aqualoon.

■ **Aqualoon filter.** For pools up to 15 m³. 10,5 l tank. Flow rate: 3,8 m³/h. 32 and 38 mm connections. Include 256 g Aqualoon.

■ **Système de filtration Aqualoon.** Pour les piscines jusqu'à 15 m³. Cuve 10,5 l. Débit 3,8 m³/h. Embouts soudés 32 et 38 mm. Comprend 256 g Aqualoon.

■ **Sistema di filtrazione Aqualoon.** Per piscine fino a 15 m³. Filtro 10,5 l. Portata 3,8 m³/h. Raccordi 32 e 38 mm. Include 256 g di Aqualoon.



CBX PACK 1





FAQ200

- **Filtro Aqualoon.** Tanque 200 mm. Caudal: 4 m³/h. Filtra cualquier residuo hasta 3 micras. Conexiones 32 y 38 mm. Incluye 320 g de Aqualoon.
- **Aqualoon filter.** 200 mm tank. Flow rate: 4 m³/h. Filters any residue until 3 micron. 32 and 38 mm connections. Include 320 g Aqualoon.
- **Système de filtration Aqualoon.** Cuve 200 mm. Débit 4 m³/h. Filtre n'importe quel résidu jusqu'à 3 microns. Embouts soudés 32 et 38 mm. Comprend 320 g Aqualoon.
- **Sistema di filtrazione Aqualoon.** Filtro 200 mm. Portata 4 m³/h. Filtra qualsiasi residuo fino a 3 micron. Raccordi 32 e 38 mm. Include 320 g di Aqualoon.

CAQ70

- **Cartucho Aqualoon tipo A**
- **Type a Aqualoon cartidge**
- **Cartouche Aqualoon de type A**
- **Cartuccia Aqualoon tipo A**



CBX PACK 12



CBX PACK 1



AQ700

CFAQ35

- **Filtro de cartucho con Aqualoon.** Caudal: 3,5 m³/h. Filtra cualquier residuo hasta 3 micras. Conexiones 32 y 38 mm. Incluye 70 g de Aqualoon.
- **Cartridge filter with Aqualoon.** Flow rate: 3,5 m³/h. Filters any residue until 3 micron. 32 and 38 mm connections. Include 70 g Aqualoon.
- **Purateur à cartouche avec Aqualoon.** Débit 3,5 m³/h. Filtre n'importe quel résidu jusqu'à 3 microns. Embouts soudés 32 et 38 mm. Comprend 70 g Aqualoon.
- **Filtri a cartuccia con Aqualoon.** Portata 3,5 m³/h. Filtra qualsiasi residuo fino a 3 micron. Raccordi 32 e 38 mm. Include 70 g di Aqualoon.

AQ700 | AQ700B

- **Medio filtrante Aqualoon.** 700gr de Aqualoon = 25 kg de ARENA. Filtra cualquier residuo hasta 3 micras. Polietileno 100% reciclable.
- **Aqualoon filter media.** 700gr Aqualoon = 25 kg SAND. Filters any residue up to 3 microns. Polyethylene 100% recyclable.
- **Moyen de filtration Aqualoon.** 700g d'Aqualoon = 25 kg de SABLE. Filtre n'importe quel résidu jusqu'à 3 microns. Polyéthylène 100% recyclable.
- **Sistema filtrante Aqualoon.** 700gr de Aqualoon = 25 kg de ARENA. Filtra qualsiasi residuo fino a 3 micron. Polietilene riciclabile al 100%.



AQ700

CBX PACK 36



CBX PACK 1



AQ700B

BX PACK 12



■ LOCALES TÉCNICOS ■ TECHNICAL ROOMS
 ■ LOCAL TECHNIQUE ■ LOCALE TECNICO



787247 | 787248 | 787249

■ **Pino silvestre autoclave classe III.** Paneles pre-ensamblados para montarlo usted mismo. Para todos los tipos de piscinas. Apertura superior mediante trampilla. Se puede adosar a la piscina o a una pared (con fondo).

■ **Autoclave class III pine.** Pre-assembled panels for you to assemble yourself. For all types of swimming pools. Top opening through a flap. To fit to a pool or to a wall (with a base).

■ **En pin Sylvestre autoclave classe III.** Panneaux pré-assemblés, à monter soi même. Pour tous types de piscine. Ouverture sur le dessus par une trappe. À adosser à la piscine ou à un mur (avec fond).

■ **Pino silvestre trattamento in autoclave classe III.** Pannelli pre-assemblati che è possibile montare da soli. Per tutti i tipi di piscina. Apertura superiore mediante botola. Da appoggiare alla piscina o a una parete (con fondo).

TRCP96 | TRCP124

■ **Local técnico para piscinas de composite** en paneles premontados. Candado incluido (para la seguridad de los niños). Mismo diseño y acabado que las piscinas de composite.

■ **Composite technical room** which consists of pre-mounted panels. A lock is included (as childrens security). Same design and finish as the composite pools.

■ **Local technique pour piscines en composite** et panneaux pré-montés. Cadenas inclus (pour la sécurité des enfants). Même style et finition que les piscines en composite.

■ **Locale tecnico per piscina in materiale composito** a pannelli premontati. Lucchetto incluso (per la sicurezza dei bambini). Design e finitura identiche a quelle della piscina in materiale composito.

	787247	787248	787249
		100 x 88 cm	
	H. 118 cm	H. 131 cm	H. 143 cm
		BXL PACK 1	

	TRCP96	TRCP124
		80 x 60 cm
	H. 89 cm	H. 119 cm
		BXL PACK 1

■ complementos ■ complements ■ complements ■ complementi

■ **FILTROS DE CARTUCHO ■ CARTRIDGE FILTER**
 ■ **EPURATEURS À CARTOUCHE ■ FILTRI A CARTUCCIA**

■ Están especialmente concebidos para piscinas con un volumen de agua medio-inferior. Son muy sencillos de utilizar y su mantenimiento se limita a la limpieza o sustitución del cartucho o filtro de recambio cuando este ha quedado obstruido por la excesiva carga de suciedad.

■ Specially designed for medium-low water volume pools. Cartridge filters are very easy to use and their maintenance is limited to the cartridge cleaning or replacement when dirt is blocking it.

■ Ils sont spécialement conçus pour les piscines avec un volume d'eau moyen inférieur. Ils sont très faciles à utiliser et l'entretien se limite au nettoyage ou au remplacement de la cartouche ou du filtre, quand il est bouché par un excès de saletés.

■ Pensati specialmente per piscine con un volume di acqua medio-basso. Sono molto semplici da usare e la manutenzione si limita alla pulizia o sostituzione della cartuccia o della cartuccia di ricambio, quando questa è ostruita da eccessive impurità.



REF. AR125



REF. AR124
REF. AR121E



REF. CFS20



AR125	3800 l/h	70 W	AR82	BXL PACK 1	8 4 1208 1 9703 18
AR124	3800 l/h	70 W	AR82	BXL PACK 1	8 4 1208 1 2031 64
AR121E	2000 l/h	72 W	AR86	BXL PACK 1	8 4 1208 1 2101 93
CFS20	2000 l/h	35 W	CCFS20	BXL PACK 1	8 4 1208 1 3184 31

■ **CARTUCHOS**
 ■ **CARTRIDGES**
 ■ **CARTOUCHES**
 ■ **CARTUCCIA**



REF. AR79

- Cartoucho de tipo A para piscina autoportante
- Type A Cartridge inflatable pool
- Cartouche de type A piscine autoportante
- Cartuccia tipo A piscina autoportante



REF. AR86

- Cartucho
- Cartridge
- Cartouche
- Cartuccia



AR86	AR121/118	CS PACK 12	8 4 1208 1 2034 09
AR82	AR125/124/118	CS PACK 12	8 4 1208 1 9703 25
AR89	AR11806	CS PACK 12	8 4 1208 1 2170 17
AR79	Type A	PB PACK 18	8 4 1208 1 2417 08
CCFS20	CFS20	PB PACK 12	8 4 1208 1 3195 51

■ MANGUERAS DE FILTRACIÓN ■ FILTRATION HOSES
 ■ TUYAUX POUR ÉPURATEURS ■ TUBI DI FILTRAZIONE

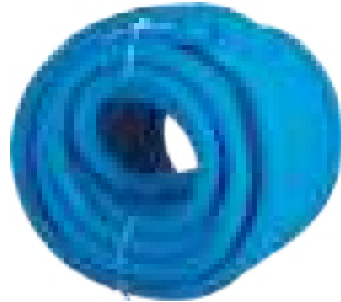

90160 | 90161

- Manguera seccionable
- Sectionable hose
- Tuyau sectionnable
- Tubo sezionabile

90160



36,5 m - Ø38 mm



BX PACK 1



8 427370 901607

90161



36,5 m - Ø32 mm



BX PACK 1



8 427370 901614



40180 | 40181

- Manguera para filtro 4 m con 2 terminales
- Filter hose 4 m with 2 cuffs
- Tuyau pour filtration 4 m avec 2 embouts
- Tubo filtrante 4 m con 2 terminali

40180



Ø38 mm



BX PACK 1



8 427370 401800

40181



Ø32 mm



BX PACK 1



8 427370 401817



60222 | 60218 | 60205

- Manguera de conexión
- Connection hose.
- Tuyau de jonction
- Tubo di giunzione.

60222



68 cm - Ø38 mm



PB PACK 10



8 427370 602221

60218



58 cm - Ø38 mm



PB PACK 10



8 427370 602184

60205



36 cm - Ø38 mm



PB PACK 10



8 427370 602054



AR2100

- Kit mangueras filtración
- Filtration hoses kit
- Kit tuyaux pour épurateurs
- Kit tubi di filtraggio.



2 (Ø38 mm x 4,5 m) + 1 (Ø38 mm x 1,5 m)
 + 1 (Ø38 mm x 0,68 m) + 1 (Ø38 mm x 0,58 m) +
 1 (Ø38 mm x 0,40 m) + 7 ■ abrazaderas ■ clamps
 ■ colliers ■ fascette



BX PACK 1



8 412081 202518

■ ADAPTADORES ■ ADAPTERS
■ ADAPTEURS ■ ADATTATORI



40091

- Quitavueeltas para manguera Ø38 mm
- Ø38 mm hose adaptor with threaded connection
- Raccord tournant pour tuyaux Ø38 mm
- Adattatore per tubo Ø38 mm



BX PACK 12



8 427370 400919



AR509

- 2 conectores Ø38 mm + 4 abrazaderas Ø38 mm
- 2 connectors Ø38 mm + 4 clamps Ø38 mm
- 2 manchons pour branchement tuyaux Ø38 mm + 4 colliers Ø38 mm
- 2 raccordi Ø38 mm + 4 fascette Ø38 mm



CS PACK 10



8 412081 209685



AR511

- 2 conectores Ø38/32 mm + 4 abrazaderas Ø38/Ø32 mm
- 2 connectors Ø38/32 mm + 4 clamps Ø38/Ø32 mm
- 2 manchons pour branchement tuyaux Ø38/32 mm + 4 colliers Ø38/Ø32 mm
- 2 raccordi Ø38/32 mm + 4 fascette Ø38/Ø32 mm



CS PACK 10



8 412081 215792



40009

- Unión 2 mangueras flotantes Ø38 mm y 32 mm
- 2 vacuum hoses union Ø38 mm and 32 mm
- Liaison pour tuyaux flottants Ø38 mm et 32 mm
- Raccordo per unire 2 tubi Ø32 mm - 38 mm



DIS PACK 12



8 427370 400094



40095

- Adaptador de mangueras Ø38/32 mm
- Ø38/32 mm hose adapter
- Adaptateur de tuyaux Ø38/32mm
- Adattatore per tubo Ø32/38 mm



BX PACK 12



8 427370 400957

■ MEDIOS FILTRANTES ■ FILTER MEDIA ■ MÉDIAS FILTRANTS ■ CARICO FILTRO



AR200

- Arena - Silex
- Sand - Silex
- Sable - Silex
- Sabbia - Silex

	25 Kg
	0,4 - 0,8 mm
	PB PACK 1 PALET 40U.
	8 4 12081 960180



VF025

- Vidrio filtrante
- Glass filter media
- Verre filtrant
- Vetro filtrante

	25 Kg
	0,5 - 1 mm
	PB PACK 1 PALET 50U.
	8 4 12081 240848



622564

- Sable pour Filtration. Remplir la cuve au 3/4 maximum. Compatible avec tout type de produits de traitement de l'eau.

	25 Kg
	0,5 - 2 mm
	Palette de 48 sacs
	3 605216 225642

Référence exclusive pour la France

■ SKIMMERS PARA PISCINAS DE ACERO ■ STEEL WALL POOLS SKIMMERS
 ■ SKIMMERS POUR PISCINES AVEC PAROIS EN ACIER
 ■ SKIMMERS PER PISCINA IN ACCIAIO

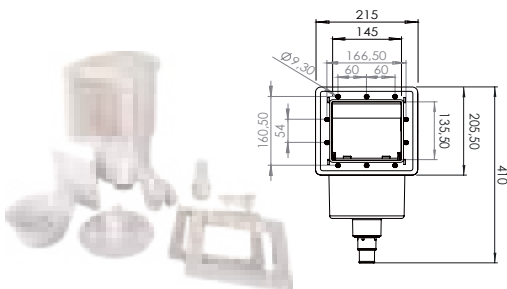

AR100

- Skimmer + boquilla de impulsión
- Skimmer + return fitting
- Skimmer + buse de refoulement
- Skimmer + bocchetta

	BXL PACK 1
	8 4 12081 950396



AR100W

- Skimmer + boquilla de impulsión
- Skimmer + return fitting
- Skimmer + buse de refoulement
- Skimmer + bocchetta

	BXL PACK 1
	8 4 12081 233192



AR100G

- Skimmer + boquilla de impulsión
- Skimmer + return fitting
- Skimmer + buse de refoulement
- Skimmer + bocchetta

	BXL PACK 1
	8 4 32611 769083



- Cómo cambiar la arena de la depuradora
- How to change the sand in a sand filter
- Comment changer le sable du filtre
- Come sostituire la sabbia del filtro



- Instalación del skimmer
- Skimmer installation
- Installation du skimmer
- Installazione dello skimmer

■ complementos ■ complements ■ complements ■ complementi

■ REPUESTOS DE FILTRACIÓN ■ FILTRATION SPARE PARTS
■ ACCESSOIRES POUR FILTRATION ■ RICAMBI PER FILTRAZIONE



AR500

- Cesto para skimmer ■ Skimmer Basket
- Panier pour skimmer ■ Cesto prefiltro



Ø ext. 16,2 cm | H. 5,5 cm | Ø int. 11 cm



CB PACK 6



AR501

- Compuerta para skimmer ■ Weir for skimmer
- Volet pour skimmer ■ Sportellino



12 x 14,5 x 2 cm



CB PACK 6



AR502

- Junta doble skimmer ■ Double seal for skimmer
- Joint double skimmer
- Guarnizione doppia standard Skimmer



ext. 20,5 x 19,5 x 0,5 cm | int. 14,8 x 13,9 x 0,5 cm



CS PACK 6



AR521

- Junta doble skimmer + 2 juntas de válvula de retorno ■ Double seal for skimmer + 2 seals for return valve
- Joint double skimmer + 2 joints pour buse de refoulement ■ Guarnizione doppia standard Skimmer + 2 guarnizioni per la valvola di ritorno



CS PACK 12



AR505

- Tapa para conexión de manguera limpiafondos
- Lid for connecting the vacuum hose to the skimmer
- Couvercle pour relier le tuyau flottant au skimmer
- Adattatore per puliscifondo



CS PACK 8



AR503

- Boquilla de impulsión
- Return fitting
- Buse de refoulement
- Valvola di impulsione completa



CBX PACK 6



AR506

- Manómetro ■ Pressure gauge
- Manomètre ■ Manometro



CBX PACK 8



AR508

- Zuncho universal ■ Filter ring
- Collier de fixation ■ Ghiera filtro



CBX PACK 6





AR512

- Válvula apertura/cierre Ø38-Ø32 mm
- Open/close valve Ø38-Ø32 mm
- Vanne ouverture/fermeture Ø38-Ø32 mm
- Valvula di apertura/chisura Ø38-Ø32 mm



CBX PACK 12



621702

- Válvula cuarto de vuelta
- ¼ Turn valve
- Vanne ¼ de tour
- Valvola ¼ di giro



CBX PACK 12



AR510

- Cintaflón y 4 abrazaderas
- Cintasflon and 4 clamps
- Teflon et 4 colliers
- Nastro Teflon e 4 fascette



CBX PACK 24



WFL6

- Esponjas absorbentes de grasa - 6 unidades
- Grease absorbing sponge for skimmer - 6 units
- Eponges absorbantes de residus gras - 6 unités
- Spugne che assorbe e trattiene le sostanze grasse - 6 unità



DIS PACK 12



FSK10

- 10 filtros de skimmer con velcro
- 10 prefiltres jetables de skimmer avec velcro
- 10 pre-filter fabric bag for use in skimmer using velcro
- 10 filtri di skimmer con velcro



DIS PACK 12



40045

- 10 filtros de skimmer
- 10 filter savers
- 10 filtres pour skimmer
- 10 filtri di skimmer



CBX PACK 12



■ SKIMMER UNIVERSAL ■ UNIVERSAL SKIMMER
 ■ SKIMMER UNIVERSEL ■ SKIMMER UNIVERSAL



778200

- Skimmer de boca ancha para piscina de madera + boquilla de impulsión
- Wide mouth skimmer for wooden Pool + return valve
- Ensemble skimmer grande ouverture pour piscines bois + buse de refoulement
- Skimmer bocca larga piscina Madera + valvola di ritorno



BXL PACK 1



778198

- Skimmer universal + boquilla de impulsión
- Universal Skimmer + return valve
- Ensemble skimmer petite ouverture universel + buse de refoulement
- Skimmer universale + valvola di ritorno



BXL PACK 1



778193

- Compuerta de recambio para el skimmer
- Spare flap for the skimmer
- Vanne de rechange pour le skimmer
- Paratoia di ricambio per skimmer



CS PACK 12



625028

- Tapa para skimmer
- Cover for skimmer
- Couvercle pour skimmer
- Lid per skimmer



CB PACK 12



778194

- Cesto para skimmer
- Skimmer Basket
- Panier pour skimmer
- Cesto prefiltro



Ext. Ø 16cm | Int. Ø 12 cm | H. 7,5 cm



CS PACK 6



770359

- Tapa para conexión de manguera limpiafondos
- Lid for connecting the vacuum hose to the skimmer
- Couvercle pour relier le tuyau flottant au skimmer
- Adattatore per puliscifondo



Ø 32/38 mm



CB PACK 12



■ CONECTIVIDAD ■ CONNECTIVITY
■ CONNECTIVITÉ ■ CONNETTIVITÀ



NEW
2024

WA000082 IQBRIDGE ZB

- **Pasarela inalámbrica** que transforma los productos conectados por Bluetooth en productos conectados a la nube para un control de aplicaciones perfecto. Control remoto por Wi-Fi para enchufes inteligentes en cualquier momento y lugar.
- **Wireless gateway solution**, transforming Bluetooth connected products into cloud-connected products for seamless app control. Remote control over Wi-Fi for Smart Plugs anytime and anywhere.
- **Solution de passerelle sans fil**, transformant les produits connectés par Bluetooth en produits connectés au cloud pour un contrôle transparent des applications. Contrôle à distance par Wi-Fi des prises intelligentes, à tout moment et en tout lieu.
- **Soluzione gateway wireless**, che trasforma i prodotti connessi al Bluetooth in prodotti connessi al cloud per un controllo app continuo. Controllo remoto tramite Wi-Fi per le spine intelligenti, sempre e ovunque.



CBX PACK 10



NEW
2024

76671 76673 SMART PLUG

- El **enchufe inteligente Smart Plug** ofrece control Plug & Play a través de Bluetooth y está diseñado específicamente para equipos de filtración, iluminación o control de electrolisis de sal. Tiene clasificación IP55, está diseñado para uso en exteriores e incluye programación ampliada para el encendido y apagado automático de los equipos de la piscina, incluida la selección del color de la luz.
- A solution to easily manage above ground pool equipment. **Smart Plug** offers Plug & Play control over Bluetooth and is specifically designed for filter pumps, lighting, or salt-water chlorinator control. It's IP55 rated, designed for outdoor use, and includes extended scheduling for automatic turning ON and OFF pool equipment, including color light selection.
- Une solution pour gérer facilement l'équipement des piscines hors sol. **La prise intelligente Smart Plug** offre un contrôle Plug & Play via Bluetooth et est spécialement conçue pour les pompes de filtration, l'éclairage ou le contrôle de l'électrolyseur d'eau de mer. Elle est conforme à la norme IP55, conçue pour une utilisation en extérieur, et comprend une programmation étendue pour l'allumage et l'extinction automatiques des équipements de piscine, y compris la sélection de la couleur de l'éclairage.
- Una soluzione per gestire facilmente le attrezzature delle piscine fuori terra. **La spina intelligente Smart Plug** offre un controllo Plug & Play tramite Bluetooth ed è progettata specificamente per le pompe di filtraggio, l'illuminazione o il controllo del cloratore ad acqua salata. È classificato IP55, è progettato per l'uso all'aperto e include una programmazione estesa per l'accensione e lo spegnimento automatico delle attrezzature della piscina, compresa la selezione del colore della luce.

76671

76673



Europe

FR · BE · CZ · SK · PL



CBX PACK 12

CBX PACK 12



■ ANALIZADOR INTELIGENTE PARA LA PISCINA ■ SMART POOL ANALYSER
 ■ ANALYSEUR INTELLIGENT POUR LA PISCINE ■ ANALIZZATORE INTELLIGENTE PER PISCINA



blueconnect Go

73014

■ **Sensor innovador todo en uno.** Mide los principales parámetros de la piscina: Temperatura, pH, Nivel desinfectante (ORP).

■ **Innovative all-in-one sensor.** Measure main parameters of pools: Temperature, pH, Disinfectant level (ORP).

■ **Capteur innovant tout en un.** Mesure les principaux paramètres de la piscine: température, pH, niveau de désinfectant (ORP).

■ **Innovativo sensore tutto in uno.** Misura i principali parametri della piscina: Temperatura, pH, livello disinfettante (ORP).



CBX PACK 1

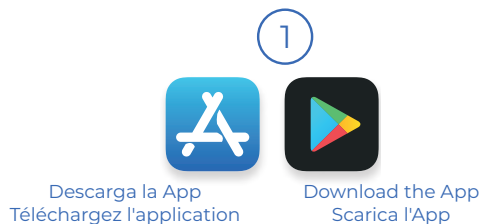

- Cómo instalar el Blue Connect
- How to install Blue Connect
- Comment installer Blue Connect
- Come installare Blue Connect



- Analiza el agua de la piscina con Blue Connect
- Test your pool water with Blue Connect
- Testez l'eau de votre piscine avec Blue Connect
- Testate l'acqua della vostra piscina con Blue Connect



7015C001

- Batería para el Blue Connect. Batería de litio de cloruro de tionilo.
- Battery for the Blue Connect. Lithium thionyl chloride battery.
- Batterie pour le Blue Connect. Batterie en lithium-chlorure de thionyle.
- Batteria per il Blue Connect. Batteria al litio cloruro di tionile.



BXL PACK 1



7015R003

- Blue Sensor es un sensor compatible con Blue Connect con vida útil de 2 temporadas.
- Blue Sensor is compatible with Blue Connect with a useful life of 2 seasons.
- Blue Sensor est un capteur compatible avec le Blue Connect dont la durée de vie est de 2 saisons.
- Blue Sensor è un sensore compatibile con Blue Connect con vita utile pari a 2 stagioni.



BXL PACK 1



7015R002

- Blue Sensor Au (oro) especial electrólisis.
- Blue Sensor Au (gold) special for salt chlorinator.
- Blue Sensor Au spécial pour électrolyse au sel.
- Blue Sensor Au (oro) speciale per elettrolisi salina.



BXL PACK 1



7015C004

- Puente wifi bluetooth.
- Bluetooth WiFi bridge.
- Amplificateur Wi-Fi Bluetooth.
- Connessione wifi bluetooth.



BXL PACK 1



7015C002

- Blue Fit 50: adaptador tubería 50 mm.
- Blue Fit 50: 50 mm tapping saddle.
- Blue Fit 50: Adaptateur de tuyau 50 mm.
- Blue Fit 50: Adattatore per tubo da 50 mm



BXL PACK 1



71666

- Kit de calibrado.
- Blue calibration kit.
- Kit de calibration.
- Kit di calibrazione.



BXL PACK 1



Blue check

71665 (EN/ES/IT/PT)

- Tiras de prueba para analizar la calidad del agua de la piscina.
- After test to analyse water quality of the pool.



BXL PACK 144



71664 (EN/FR/DE/NL)

- Bandelettes d'analyse pour analyser la qualité de l'eau de la piscine.
- Strisce di prova per analizzare l'acqua della piscina.



BXL PACK 144



■ ELECTROLISIS DE SAL ■ SALT CHLORINATOR
 ■ ELECTROLYSE AU SEL ■ ELETTROLISI SALINA

■ Los cloradores por electrolisis de sal generan cloro para la desinfección de la piscina a partir de sal. La electrolisis de sal tiene varias ventajas: genera y dosifica automáticamente el cloro en la piscina, evita el almacenamiento y la manipulación de producto químico y es totalmente seguro, ya que sólo utiliza sal común.

■ L'électrolyse au sel présente plusieurs avantages. Elle génère et dose automatiquement le niveau de chlore dans la piscine, évite le stockage et la manipulation de produits chimiques et est totalement sûre pour la santé, étant donné que le sel utilisé est du sel naturel et commun à tout le monde.

■ Through electrolysis of salt, the chlorinators generate chlorine and salt to disinfect the swimming pool. The electrolysis of salt has various advantages: Generating and automatically dosing the chlorine in the swimming pool, avoids the handling and storage of chemical products and it completely safe, using only sodium chloride.

■ I clorinatori per elettrolisi salina producono cloro per la disinfezione della piscina partendo dal sale. L'elettrolisi salina ha diversi vantaggi: produce e provvede al dosaggio automatico del cloro nella piscina, evita l'immagazzinamento e l'uso di prodotti chimici ed è del tutto sicura in quanto fa uso del sale comune.



GRE SALT SYSTEM ALL IN ONE

- Electrolisis de sal + Controlador de pH + Bomba dosificadora.
- Salt chlorinator + pH control + Dosing pump
- Electrolyse au sel + Contrôleur de pH + Pompe doseuse
- Elettrolisi salina + Regolatore di pH + Pompa per il dosaggio del prodotto chimico

GRE SALT SYSTEM

- Electrolisis de sal ■ Salt chlorinator
- Electrolyse au sel ■ Elettrolisi salina

	SCGPHP100	SCGPHP60
	100m ³	60m ³
	21 g/h	12 g/h
	BXL PACK 1	BXL PACK 1
	8 412081 307060	8 412081 313207

	SCG100	SCG60
	100m ³	60m ³
	21 g/h	12 g/h
	BXL PACK 1	BXL PACK 1
	8 412081 273655	8 412081 273662



- Instalación
- Installation
- Installation
- Installazione



**dream
salt**

NEW
2024



DREAM SALT

- Clorador salino para piscinas elevadas
Fácil de utilizar. Incluye temporizador. Plug & Play con conectores de 32/38 mm. Puede gestionarse mediante un Smart Plug para conseguir un ecosistema.
- Saltwater chlorinator for above ground pools
Easy to use. Includes a timer. Plug & Play with 32/38 mm connectors. Can be managed by a Smart Plug to achieve an ecosystem.
- Electrolyse au sel pour piscine hors sol
Facile à utiliser. Comprend une minuterie. Plug & Play avec des connecteurs de 32/38 mm. Peut être géré par une prise intelligente pour créer un écosystème.
- Elettrolisi salina per piscina fuori terra
Facile da usare. Include un timer. Plug & Play con connettori da 32/38 mm. Può essere gestito da una Smart Plug per ottenere un ecosistema.

GSS50

GSS25

	50m ³	25m ³
	10 g/h	5 g/h
	CBX PACK 1	CBX PACK 1
	 8 412081 289779	 8 412081 290072



GRE BALANCE

- Electrolisis de sal
- Salt chlorinator
- Electrolyse au sel
- Elettrolisi salina

EESB55

	55 m ³
	8 g/h
	CBX PACK 1
	 8 412081 264875



AR2000

Kit Bypass

- Contiene: 3 Válvulas apertura/cierre + 2 mangueras Ø38 mm x 1,5 m + 6 piezas de reducción Ø38 - 50 mm para encolar + 4 abrazaderas
- Contains: 3 opening/closing valves + 2 hoses Ø38 mm x 1,5 m + 6 reduction parts Ø38 - 50 mm to glue + 4 lamps
- Comprend: 3 vannes ouverture / fermeture + 2 tuyaux Ø38 cm x 1,5 m + 6 pièces réduction Ø38 - 50 mm à coller + 4 colliers
- Contiene: 3 valvole di apertura/chiusura + 2 tubi flessibili Ø38 cm x 1,5 m + 6 pezzi adattatori Ø38 - 50 mm da incollare + 4 fascette



BXL PACK 1



■ complementos ■ complements ■ complements ■ complementi

■ SAL ESPECIAL PARA PISCINA ■ POOL SALT
 ■ SEL SPÉCIAL PISCINE ■ SALE PER PISCINE



90365

- **Sal compacta** para piscinas equipadas con sistema de tratamiento de agua por cloración salina.
- **Compact salt** for swimming pools equipped with a salt chlorination water treatment system.
- **Sel compact** pour les piscines équipées d'un système de traitement de l'eau par chloration au sel.
- **Sale compatto** per piscine dotate di un sistema di trattamento dell'acqua con clorazione a sale.



25 Kg



PB PACK 1
PALET 40U.



8 427370 90365 1



NEW
2024

90366

- **Sal marina granulada** para piscinas. Apto para todas las superficies, liner incluido.
- **Granulated sea salt** for swimming pools. Suitable for all surfaces, liner included.
- **Sel marin granulé** pour les piscines. Convient à toutes les surfaces, doublure incluse.
- **Sale marino granulare** per piscine. Adatto a tutte le superfici, liner inclusa



25 Kg



PB PACK 1
PALET 40U.



8 412081 290362

■ BOMBA DOSIFICADORA Y CONTROLADOR ■ POOL DOSING SYSTEMS
 ■ CONTRÔLEUR DE PH ET POMPE DOSEUSE ■ REGOLATORE E DOSATORE



CPH14

- El **controlador de pH con bomba peristáltica** para piscina enterrada automatiza la regulación del pH, lo que permite estabilizar el pH en el valor ideal para su confort y optimizar la eficacia del tratamiento de desinfección.
- **pH-Control dosing system** is a peristaltic pump designed to maintain a chosen pH level on inground pools, allowing stabilize the pH in the ideal value for comfort and to optimize the efficiency of the disinfection treatment.
- Le **contrôleur de pH avec pompe péristaltique** pour piscine enterrée automatise la régulation du pH, ce qui permet de stabiliser le pH sur la valeur idéale pour votre confort et optimiser l'efficacité du traitement de désinfection.
- Il **regolatore di pH con pompa peristaltica** per piscine interrata automatizza la regolazione del pH consentendo di stabilizzarlo su un valore ideale e ottimizzando l'efficacia del trattamento di disinfezione.



BXL PACK 1



8 412081 259006



BDP4

- **Bomba dosificadora peristáltica.** Caudal variable 4 l/h y 1,5 Bar. Permite dosificar el producto químico de forma fácil y segura.
- **Peristaltic dosing pump.** Variable flow rate. 4 l/h and 1,5 Bar. Safe and easy way of dosing of the chemical product UV-C.
- **Pompe doseuse péristaltique.** Vitesse variable 4 l/h et 1,5 bar. Permet le dosage de produit chimique de façon facile et précise.
- **Pompa per il dosaggio del prodotto chimico.** Pressione variabile 4 l/h e 1,5 Bar. Consente un dosaggio facile e sicuro del prodotto chimico.



BXL PACK 1



8 412081 250694

■ DESINFECCIÓN ■ DISINFECTION ■ DÉSINFECTION ■ DISINFEZIONE



UVC25

■ **Sistema de desinfección UV** para piscinas de hasta 25 m³. Reduce la necesidad de cloro en hasta un 70%. Para piscinas enterradas y elevadas. Producto ecológico. Hecho en Europa

■ **UV Disinfection system** for pools up to 25 m³. It reduces up to 70% of chlorine need. For In-ground and above ground pools. Ecological product Made in Europe

■ **Système de désinfection par UV** pour piscines jusqu'à 25 m³. Réduit les besoins en chlore jusqu'à 70%. Pour piscines enterrées et hors sol. Produit respectueux de l'environnement. Fabriqué en Europe

■ **Sistema di disinfezione UV** per piscine fino a 25 m³. Riduce il bisogno di cloro fino al 70%. Per piscine interrate e fuori terra. Prodotto ecologico. Prodotto in Europa



- Instalación
- Installation
- Installation
- Installazione



BXL PACK 1



■ ILUMINACIÓN PARA PISCINAS ENTERRADAS Y PISCINAS MADERA
 ■ LIGHTING FOR IN GROUND AND WOODEN POOLS
 ■ ECLAIRAGE POUR PISCINES ENTERRÉES ET BOIS
 ■ ILLUMINAZIONE PER PISCINE INTERRATE ED IN LEGNO



PLREB

- **Proyector led blanco.** No incluye transformador.
- **White led projector.** Light transformer not included.
- **Projecteur led blanche.** Transformateur de lumière non inclus.
- **Faretto led bianco.** Trasformatore di luce non incluso.



16W



12V AC 50/60Hz



1485 lm



BXL PACK 1



PLREC

- **Proyector led color.** Con control remoto. No incluye transformador.
- **Colour led projector.** With remote control. Light transformer not included.
- **Projecteur led couleur.** Avec télécommande. Transformateur de lumière non inclus.
- **Faretto led multicolor.** Include telecomando. Trasformatore di luce non incluso.



16W



12V AC 50/60Hz



1100 lm



BXL PACK 1



■ ILUMINACIÓN PARA PISCINAS ENTERRADA ■ LIGHTING FOR IN GROUND
 ■ ECLAIRAGE POUR PISCINES ■ ILLUMINAZIONE PER PISCINE INTERRATE



LEDP56WP

- **Lámpara led blanca PAR56.** Muy fácil instalación. 100% fabricada en EU (fábrica propia). 1300 lúmenes.
- **PAR56 white led lamp.** Easily installed lamp. 100% manufactured in EU (own production). 1300 lumens.
- **Ampoule led blanche PAR56.** Très facile à installer 100% fabriquée en Europe (usine propre). 1300 lumens.
- **Lampada PAR56 led bianca.** Lampada di semplicissima installazione, prodotta al 100% in EU (produzione propria). 1300 lumen.



LEDP56CE

- **Lámpara led color PAR56.** Muy fácil instalación 100% fabricada en EU (fábrica propia).
- **PAR56 colour led lamp.** Easily installed lamp. 100% manufactured in EU (own production).
- **Ampoule led couleur PAR56.** Très facile à installer 100% fabriquée en Europe (usine propre).
- **Lampada led color PAR56.** Lampada di semplicissima installazione, prodotta al 100% in EU (produzione propria).

	11,5 W
	12 V
	1300 lm
	L70 - 25000 h
	CBX PACK 1

	15 W
	12 V
	900 lm
	L70 - 25.000 h
	CBX PACK 1



- Cómo cambiar una lámpara LED de piscina
- How to replace an LED pool light
- Comment remplacer une lampe de piscine à LED
- Come sostituire una luce LED per piscina

- ILUMINACIÓN PARA PISCINAS SOBRE SUELO
- ABOVE GROUND POOLS LIGHTING
- ÉCLAIRAGE POUR PISCINES HORS SOL
- ILLUMINAZIONE PER PISCINE FUORI TERRA



PLWPB

■ **Proyector led blanco para piscinas de madera y composite.**
Led de bajo consumo. Fácil instalación. Gran calidad: Fabricado en Europa. Incluye transformador.

■ **White led projector for wooden and composite pools.**
Low consumption LED. Easy installation, since a standard plug is included. High quality: Made in Europe. Transformer included.

■ **Projecteur led blanc pour piscines en bois et composite.**
Led à basse consommation. Facile à installer. Grande qualité: fabriqué en Europe. Comprend: transformateur.

■ **Proiettore a led bianco per piscine in legno e composito.**
Led a basso consumo Semplice da installare. Qualità elevata: Prodotto in Europa. Transformador.



- Instalación
- Installation
- Installation
- Installazione

	16 W
	12 V
	1485 lm
	25000 h
	5 m
	CBX PACK 4
	8 412081 302799



LEDRW

■ **Proyector led blanco para piscinas elevadas** autoportantes y de pared rígida. Alto rendimiento para conectar a la válvula de retorno. Caudal mínimo necesario: 3.000 l/h. Funciona sin necesidad de batería.

■ **White led projector for movable above ground pools** with rigid walls. For connecting to the return valve. High performance WHITE LEDs. Generates light at no cost, does not need batteries. Minimal flow needed: 3000 l/h

■ **Projecteur led blanche adaptable à des piscines hors-sol,** aussi bien autoportantes qu'avec des parois rigides. À haut rendement pour connecter à la buse de refoulement. Débit minimum nécessaire : 3 000 l/h. Fonctionne sans nécessité de batterie.

■ **Proiettore led bianco a resa elevata,** si adatta a piscine fuori terra, sia autoportanti che a parete rigida. Per connessione alla valvola di ritorno. Flusso minimo necessario: 3.000 l/h. Funziona senza batteria.



	CBX PACK 12
	8 412081 257464



LEDRC

■ **Proyector led color para piscinas elevadas** autoportantes y de pared rígida. Alto rendimiento para conectar a la válvula de retorno. Caudal mínimo necesario: 3.000 l/h. Funciona sin necesidad de batería.

■ **Colour led projector for movable above ground pools** with rigid walls. For connecting to the return valve. High performance COLOUR LEDs. Generates light at no cost, does not need batteries. Minimal flow needed: 3000 l/h

■ **Projecteur led couleur adaptable à des piscines hors-sol,** aussi bien autoportantes qu'avec des parois rigides. À haut rendement pour connecter à la buse de refoulement. Débit minimum nécessaire : 3 000 l/h. Fonctionne sans nécessité de batterie.

■ **Proiettore led color a resa elevata,** si adatta a piscine fuori terra, sia autoportanti che a parete rigida. Per connessione alla valvola di ritorno. Flusso minimo necessario: 3.000 l/h. Funziona senza batteria.

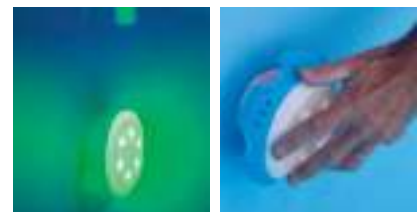

	CBX PACK 12
	8 412081 257471



PLED2

■ **Conjunto de 2 proyectores led blancos** para piscina elevada de acero y autoportantes. Fácil instalación, se pega a la chapa mediante imán. Incorpora mando a distancia para fácil manejo. Tecnología Led de bajo consumo. Funciona con pilas (3 pilas AA no incluidas).

■ **Set of 2 white led projectors** for above ground pools. Stick to the sheet with a magnet and ready to use. Includes remote control for easy operation. Energy-saving led technology. Requires 3 AA batteries (not included).

■ **Ensemble de 2 projecteurs led** pour piscine hors sol. Ils est spécialement conseillé pour les piscines hors sol en tôle. Se fixe simplement sur la tôle grâce à un aimant. Ils sont livrés avec une télécommande très simple à utiliser. Technologie led à faible consommation. Fonctionne avec 3 piles de type AA (non incluses).

■ **2 Faretto led per piscina fuoriterra.** Foglio adesivo con un magnete pronto all'uso. Include telecomando a distanza per un facile funzionamento. Risparmio energetico tecnologia al led. 3 pile tipo AA (non include).



CBX PACK 4



8

4 12081 250830



PLED1C

■ **Proyector led color** para piscina elevada de acero. Fácil instalación, se pega a la chapa mediante un imán. Incorpora mando a distancia para fácil manejo. Tecnología Led de bajo consumo. Funciona con pilas (3 pilas AA no incluidas).

■ **Color led projector** for above ground pools. Stick to the sheet with a magnet and ready to use. Includes remote control for easy operation. Energy-saving led technology. Requires 3 AA batteries (not included).

■ **Projecteur led de couleur** pour piscine hors sol. Ils sont spécialement conseillés pour les piscines hors sol en tôle. Se fixe simplement sur la tôle grâce à un aimant. Ils sont livrés avec une télécommande très simple à utiliser. Technologie led à faible consommation. Fonctionne avec 3 piles de type AA (non incluses).

■ **Faretto led multicolor** per piscina fuoriterra. Foglio adesivo con un magnete pronto all'uso. Include telecomando a distanza per un facile funzionamento. Risparmio energetico tecnologia al led. 3 pile tipo AA (non include).



CBX PACK 6



8

4 12081 257518



LAGP8

■ **Proyector colgante led** para piscina elevada. Incluye 7 m de cable + enchufe. Hecho en Europa. Larga vida útil.

■ **Led Hanging Projector** for above ground pools. It includes 7 m cable + plug. Made in Europe. Long life.

■ **Projecteur suspendu à led** pour piscines hors sol. Comprend un câble de 7 m + une prise. Fabriqué en Europe. Longue durée de vie.

■ **Faretto a sospensione a led** per piscina fuori terra. Include 7 m di cavo + spina. Prodotto in Europa. Lunga durata di vita.



- Instalación
- Installation
- Installation
- Installazione



8 W



880 lm



CBX PACK 1



8

4 12081 319070

■ CALEFACCIÓN SOLAR ■ SOLAR HEATING SYSTEM
 ■ CHAUFFAGE SOLAIRE ■ RISCALDAMENTO SOLARE

- Sistemas para calentamiento del agua de la piscina mediante la acción solar. ■ Solar pool water heating systems.
- Chauffage solaire pour piscine. Fabriqué en polyéthylène ■ Sistema per il riscaldamento dell'acqua della piscina per mezzo dell'azione del sole.



AR2069

■ **Calentador solar** fabricado en polietileno. Aumenta la temperatura del agua hasta 6°C. Más de 12 kw/h de calor al día. 600x60 cm. Peso 7 kg. Potencia de la bomba mínima recomendada: 1/3 CV.

■ **Solar heater** made of polythene. Water temperature can be increased up to 6°C. 600x60 cm. Wight: 7 kg. Minimum recommended pump output: 1/3 hp.

■ **Chauffage solaire** augmente la température de l'eau jusqu'à 6°C. Dimensions du produit : 600x60 cm. Poids 7 kg. Puissance de la pompe minimale recommandée: 1/3 CV.

■ **Riscaldatore solare** in polietilene. Aumenta la temperatura dell'acqua fino a 6°C. 600x60 cm. Peso 7 kg. Potenza minima della pompa raccomandata: 1/3 CV.



90230

■ **Calentador solar.** Permite aumentar la temperatura de su piscina por la acción del sol. Los calentadores pueden conectarse entre sí en serie. Aumenta la temperatura del agua 3°C en piscinas entre 7,5 m³ y 10 m³.

■ **Solar pool water heating system.** The heaters should be connected in series to heat the pool. Each solar heater increases the water temperature in 3°C for pools with a volume between 7,5 and 10 m³.

■ **Système pour le chauffage solaire de l'eau de la piscine.** Les réchauffeurs peuvent se connecter entre eux en série. Augmente la température de 3°C max. pour les piscines entre 7,5 m³ y 10 m³.

■ **Riscaldatore solare.** Permette di aumentare la temperatura della sua piscina tramite l'azione dei raggi solari. Ogni riscaldatore solare permette di aumentare la temperatura della piscina no a 3°C tramite l'azione naturale del sole.



SH70

■ **Calentador solar para piscinas elevadas.** 1 unidad por cada 7 m³. Material: Colector HDPE de alta calidad con cubierta PC. Posibilidad de conectar varias unidades en línea. Fácil de instalar. Ø32/38 mm.

■ **Solar heater for above ground pools.** 1 units for each 7 m³. Material: High quality HDPE collector with PC cover. Possibility to connect several units in line. Easy to install. Ø32/38 mm.

■ **Chauffage solaire pour piscines hors sol.** 1 unité pour 7 m³. Matériau : collecteur HDPE de haute qualité avec couvercle en PC. Possibilité de connecter plusieurs unités en série. Facile à installer. Ø32/38 mm.

■ **Riscaldatore solare per piscine fuori terra.** 1 unità per 7 m³. Materiale: collettore HDPE di alta qualità con copertura in PC. Possibilità di collegare diverse unità in linea. Facile da installare. Ø32/38 mm.



CBX PACK 1



8 412081 203331



CBX PACK 1



8 427370 902307



CBX PACK 1



8 412081 319629

■ CALEFACCIÓN ■ HEATING SYSTEMS
 ■ CHAUFFAGE ■ RISCALDAMENTO

■ La bomba de calor es el método más eficiente para calentar una piscina y además, permite alargar la temporada de baño. Las bombas de calor mueven la energía térmica en la dirección opuesta a la transferencia de calor espontánea, al absorber el calor de un espacio frío y liberarlo a uno más cálido.

■ The heat pump is the most efficient method for heating a pool and in addition allows extending the bathing season. Heat pumps move thermal energy in the opposite direction to spontaneous heat transfer, by absorbing heat from a cold space and releasing it into a hotter one.

■ La pompe à chaleur est la méthode la plus efficace pour chauffer une piscine et permet également d'allonger la saison des baignades. Les pompes à chaleur déplacent l'énergie thermique dans le sens opposé au transfert de chaleur spontanée, en absorbant la chaleur d'un espace froid et en la libérant dans un espace plus chaud.

■ La pompa di calore rappresenta il metodo più efficace per riscaldare la piscina e consente di utilizzarla tutto l'anno. Le pompe di calore muovono l'energia termica in direzione opposta rispetto al trasferimento spontaneo di calore, assorbendo calore da uno spazio freddo e rilasciandolo in uno più caldo.

- Bombas de calor mini para piscinas sobre suelo
- Above ground pools mini heat pumps
- Pompes à chaleur mini pour piscines hors sol
- Pompa di calore mini per piscine fuori terra



- Instalación
- Installation
- Installation
- Installazione

mini pool heating



MINI HEAT PUMPS

■ Bomba de calor Mini para pequeño volumen de agua. No necesitan bypass. Conexiones 32 y 38 mm.

■ Mini heat pumps for reduced water volumes. Bypass not necessary. 32 and 38 mm connections.

■ Pompes à chaleur Mini pour petit volume d'eau. Elle n'a pas besoin de bypass. Embouts soudés 32 et 38 mm.

■ Pompa di calore Mini per piscine a ridotto volume di acqua. Non ha bisogno di un bypass. Raccordi 32 e 38 mm.

	HPM20	HPM30	HPM40
Aire · Air · Aria 28°C / Agua · Water · Eau · Acqua 28°C / Humedad · Humidity · Humidité · Umidità 80%			
Salida de calor · Heat output · Sortie de chaleur · Produzione di calore	2,5 kW	4,2 kW	5,5 kW
Consumo energético · Power Consumption · Consommation énergétique · Consumo di energia	0,59 kW	1,00 kW	1,31 kW
Volumen máximo de la piscina · Max Pool volume · Volume maximum de la piscine · Volume massimo della piscina	20 m ³	30 m ³	40 m ³
Aire · Air · Aria 15°C / Agua · Water · Eau · Acqua 26°C / Humedad · Humidity · Humidité · Umidità 70%			
Salida de calor · Heat Output · Sortie de chaleur · Produzione di calore	1,9 kW	3,2 kW	4,2 kW
Consumo energético · Power Consumption · Consommation énergétique · Consumo di energia	0,56 kW	0,91 kW	1,2 kW

HPM20



8 4 1208 1 3026 14

HPM30



8 4 1208 1 3031 54

HPM40



8 4 1208 1 3038 26



- Bombas de calor Full Inverter para piscinas sobre suelo y enterradas
- Full Inverter heat pumps for above and inground pools
- Pompes à chaleur Full Inverter pour piscines hors sol et enterrées
- Pompa di calore Full Inverter per piscine fuori terra e interrata

fullinverter pool heating

NEW
2024



- Control desde cualquier lugar y en cualquier momento con una interfaz intuitiva.
- Control from anywhere, at anytime with an intuitive interface.
- Contrôle de n'importe où, à n'importe quel moment, grâce à une interface intuitive.
- Controllo da qualsiasi luogo e in qualsiasi momento grazie a un'interfaccia intuitiva.

FULL INVERTER HEAT PUMPS - WITH CONNECTIVITY

■ La tecnología Full Inverter permite a la bomba de calor variar su velocidad en función de la temperatura del agua de la piscina. Por tanto, funciona para lograr la mejor eficiencia energética con el menor nivel de ruido.

■ La technologie Full Inverter permet à la pompe à chaleur de varier sa vitesse en fonction de la température de l'eau de la piscine. Elle fonctionne ainsi pour atteindre la meilleure efficacité énergétique au niveau sonore le plus bas.

■ Full Inverter technology enables a heat pump to vary its speed depending on the temperature of the pool water. It therefore runs to achieve the best energy efficiency at the lowest noise level.

■ La tecnologia Full Inverter consente alla pompa di calore di variare la propria velocità in base alla temperatura dell'acqua della piscina. In questo modo funziona per ottenere la migliore efficienza energetica con il minor livello di rumorosità.

HPGIC30 HPGIC45 HPGIC60 HPGIC75

Aire · Air · Aria 26°C / Agua · Water · Eau · Acqua 26°C / Humedad · Humidity · Humidité · Umidità 80%	HPGIC30	HPGIC45	HPGIC60	HPGIC75
Potencia calorífica · Heating capacity · Capacité de chauffage · Capacità di riscaldamento	4,5 - 2 kW	7 - 1,2 kW	9 - 1,5 kW	12 - 2,2 kW
Consumo energético · Power Consumption · Consommation énergétique · Consumo di energia	0,7 - 0,1 kW	1,1 - 0,1 kW	1,5 - 0,1 kW	2,1 - 0,1 kW
Volumen máximo de la piscina · Max Pool volume · Volume maximum de la piscine · Volume massimo della piscina	30 m ³	45 m ³	60 m ³	75 m ³
Aire · Air · Aria 15°C / Agua · Water · Eau · Acqua 26°C / Humedad · Humidity · Humidité · Umidità 70%	HPGIC30	HPGIC45	HPGIC60	HPGIC75
Salida de calor · Heat Output · Sortie de chaleur · Produzione di calore	3,5-1,4 kW	5,5 - 1,2 kW	7 - 1,6 kW	9 - 2,1 kW
Consumo energético · Power Consumption · Consommation énergétique · Consumo di energia	0,7-0,2 kW	5,5 - 1,2 kW	1,3 - 0,2 kW	1,9 - 0,3 kW

HPGIC30



HPGIC45



HPGIC60



HPGIC75



■ complementos ■ complements ■ complements ■ complementi

■ DUCHAS
■ SHOWERS
■ DOUCHES
■ DOCCIA



■ Solar ■ Solar
■ Solaire ■ Solare

■ Litros ■ Liters
■ Litres ■ Litri

■ Aluminio ■ Aluminium
■ Aluminium ■ Alluminio

■ Acero inoxidable
■ Stainless steel
■ Acier inoxydable
■ Acciaio inossidabile

■ PVC

■ Polietileno ■ Polyethylene
■ Polyéthylène ■ Polietilene

■ Grifo lavapies
■ Footwash tap
■ Robinet lave pieds
■ Rubinetto lavapiedi

■ 2 piezas ■ 2 pieces
■ 2 pièces ■ 2 pezzi

32 l 32 l 40 l 38 l 38 l 35 l 35 l 32 l

• • • • • • • • • • •

• • •

• • •

• • • • • • • • • • •

• • • • • • • • • • •

• • • • • • • • • • •



■ Solar ■ Solar
■ Solaire ■ Solare

■ Litros ■ Liters
■ Litres ■ Litri

■ Aluminio ■ Aluminium
■ Aluminium ■ Alluminio

■ Acero inoxidable
■ Stainless steel
■ Acier inoxydable
■ Acciaio inossidabile

■ PVC

■ Polietileno ■ Polyethylene
■ Polyéthylène ■ Polietilene

■ Grifo lavapies
■ Footwash tap
■ Robinet lave pieds
■ Rubinetto lavapiedi

■ 2 piezas ■ 2 pieces
■ 2 pièces ■ 2 pezzi

30 l 30 l 25 l 25 l 22 l 20 l 20 l 20 l 19 l 18 l 9 l 9 l

• • • • • • • • • • •

•

• • • • • • • • • • •

• • • • • • • • • • •

• • • • • • • • • • •

• • • • • • • • • • •

- DUCHAS MINIMAL ■ MINIMAL SHOWERS
- DOUCHES AU STYLE MINIMALISTE ■ DOCCIA MINIMAL



DAI43F | DAI43

■ **Ducha de acero inoxidable de estética minimalista.** Tubo Ø43 mm. Rociador antical. Anclaje y conexión a la toma de agua a través del suelo.

■ **Stainless steel minimalist aesthetics shower.** 43 mm diameter tube. Lime-free overhead sprayer. Assembly and water connection intake through the ground.

■ **Douche en acier inoxydable à l'esthétique minimaliste.** Tube Ø43 mm. Pommeau anti-calcaire. Fixation et branchement à l'arrivée d'eau par le sol.

■ **Doccia in acciaio inox con tratti estetici minimalisti.** Tubo Ø43 mm. Doccino anticalcare. Fissaggio e collegamento alla presa d'acqua attraverso il terreno.

	DAI43F	DAI43
	✓	-
	BXL PACK 1	BXL PACK 1

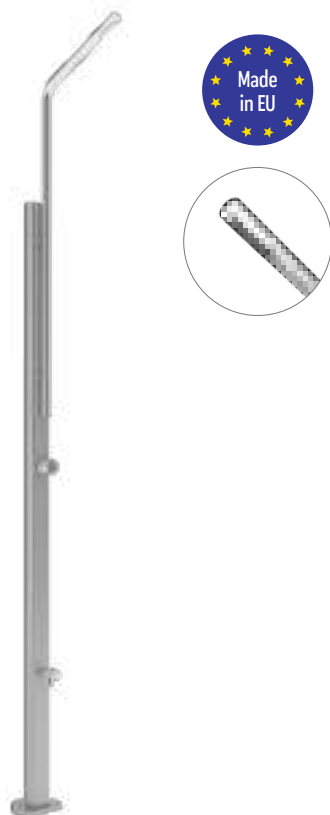

SS10NS

■ **Ducha de acero inoxidable.** Su diseño elegante y moderno se adapta a cualquier jardín o terraza. Tubo de Ø15 y altura: 220 cm. Rociador cenital antical de forma rectangular. Fácil de usar gracias al grifo regulable.

■ **Stainless steel shower.** Elegant and modern design. Tube Ø15 and height: 220 cm. Rectangular shaped, anti-limescale overhead shower head. Easy to use thanks to the mixer tap.

■ **Douche en acier inoxydable.** Grâce à son design élégant et moderne, il s'intègre dans n'importe quel jardin ou terrasse. Tuyau de Ø15 et hauteur : 220 cm. Pomme de douche anticalcaire zénithale de forme rectangulaire. Facile à utiliser grâce au robinet réglable.

■ **Doccia in acciaio inox.** Design elegante e moderno, si adatta a qualsiasi giardino o terrazza. Tubo con Ø15 e altezza: 220 cm. Soffione zenitale anti-calcare di forma rettangolare. Facile da usare grazie al rubinetto regolabile.

		✓
	BXL PACK 1	

■ DUCHAS SOLARES ■ SOLAR SHOWERS
 ■ DOUCHES SOLAIRES ■ DOCCE SOLARI



DSALR32W

- Ducha solar redonda. Aluminio aspecto madera.
- Round solar shower. Aluminium Woodlike.
- Douche solaire ronde. Aluminium Aspect bois.
- Doccia solare round. Alluminio imitazione legno.



32 L



✓



BXL PACK 1



DSALC32W

- Ducha solar cuadrada. Aluminio Aspecto madera.
- Square solar shower. Aluminium Woodlike.
- Douche solaire carrée. Aluminium Aspect bois.
- Doccia solare square. Alluminio imitazione legno.



32 L



✓



BXL PACK 1



DSALP38B

- Ducha solar premium. Aluminio.
- Solar shower. Aluminium.
- Douche solaire. Aluminium.
- Doccia solare. Alluminio.



38 L



✓



BXL PACK 1



DSALP38

- Ducha solar. Aluminio. Incluye rociador.
- Solar shower. Aluminium. Include sprayers.
- Douche solaire. Aluminium. Inclure pulvérisateur.
- Doccia solare. Alluminio. Incluso sprayers.



38 L



✓



BXL PACK 1





SSP40

- Ducha solar. PVC.
- Solar shower. PVC.
- Douche solaire. PVC.
- Doccia solare. PVC.



40 L



✓



BXL PACK 1



DSPS35

- Ducha solar. PVC.
- Solar shower. PVC.
- Douche solaire. PVC.
- Doccia solare. PVC.



35 L



✓



BXL PACK 1



AR1035P

- Ducha solar. PVC. 2 piezas.
- Solar shower. PVC. 2 pièces.
- Douche solaire. PVC. 2 pièces.
- Doccia solare. PVC. 2 pezzi.



35 L



✓



BXL PACK 1



AR1130

- Ducha solar premium. Aluminio.
- Solar shower. Aluminium.
- Douche solaire. Aluminium.
- Doccia solare. Alluminio.



32 L



✓



BXL PACK 1





AR1030

- Ducha solar. PVC.
- Solar shower. PVC.
- Douche solaire. PVC.
- Doccia solare. PVC.

	30 L
	✓
	BXL PACK 1
8 412081 220765	

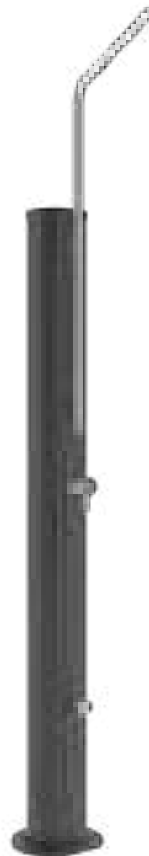

SS30S

- Ducha solar de aluminio. Acabado en negro con decoración plateada.
- Aluminium solar shower. Black spayed finish with silver decoration.
- Douche solaire en aluminium. Finition noire et argent.
- Doccia solare in alluminio. Finitura nera spayed con decorazione argento.

	30 L
	✓
	BXL PACK 1
8 412081 318752	



SSR25

- Ducha solar. Polietileno.
- Solar shower. Polyethylene.
- Douche solaire. Polyéthylène.
- Doccia solare. Polietilene.

	25 L
	✓
	BXL PACK 1
8 412081 307107	

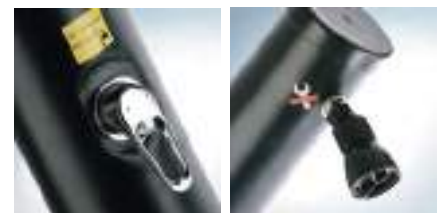

AR10250

- Ducha solar. PVC.
- Solar shower. PVC.
- Douche solaire. PVC.
- Doccia solare. PVC.

	25 L
	✓
	BXL PACK 1
8 412081 224497	



AR1022P

- **Ducha solar.** PVC. Diseño curvo
- **Solar shower.** PVC. Curved design
- **Douche solaire.** PVC. Design incurvé
- **Doccia solare.** PVC. Design curvo



22 L



BXL PACK 1



8 412081 318684



AR1020W

- **Ducha solar.** PVC aspecto madera.
- **Solar shower.** Woodlike PVC.
- **Douche solaire.** PVC Aspect bois.
- **Doccia solare.** PVC Imitazione legno.



20 L



BXL PACK 1



8 412081 264387



AR1020P

- **Ducha solar.** PVC. 2 piezas.
- **Solar shower.** PVC. 2 pieces.
- **Douche solaire.** PVC. 2 pièces.
- **Doccia solare.** PVC. 2 pezzi.



20 L



BXL PACK 1



8 412081 240817



40664A

- **Ducha solar.** PVC.
- **Solar shower.** PVC.
- **Douche solaire.** PVC.
- **Doccia solare.** PVC.



20 L



BXL PACK 1



8 427370 406645



DSM19

- **Ducha solar.** Polietileno.
- **Solar shower.** Polyethylene.
- **Douche solaire.** Polyéthylène.
- **Doccia solare.** Polietilene.



19 L



BXL PACK 1



SSAL18

- **Ducha solar.** Aluminio. 2 piezas.
- **Solar shower.** Aluminium. 2 pieces.
- **Douche solaire.** Aluminium. 2 pièces.
- **Doccia solare.** Allumini. 2 pezzi.



18 L



BXL PACK 1



AR1009

- **Ducha solar.** PVC. 2 piezas.
- **Solar shower.** PVC. 2 pièces.
- **Douche solaire.** PVC. 2 pièces.
- **Doccia solare.** PVC. 2 pezzi.



9 L



BXL PACK 1



AR1009W

- **Ducha solar.** PVC aspecto madera. 2 piezas.
- **Solar shower.** Woodlike PVC. 2 pieces.
- **Douche solaire.** PVC Aspect bois. 2 pièces.
- **Doccia solare.** PVC Imitazione legno. 2 pezzi.



9 L



BXL PACK 1



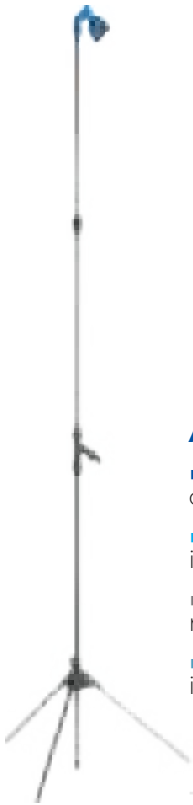

AR104

- **Ducha aluminio.** Fácil instalación y conexión.
- **Aluminium shower.** Easy installation and connection.
- **Douche en aluminium.** Montage et raccordement facile.
- **Doccia alluminio.** Facilità di installazione e collegamento.



CBX PACK 6



LP01

- Lavapiés
- Footwash
- Pédiluve
- Lavapiedi



PB PACK 6



■ RACORDERÍA ■ PVC FITTINGS
 ■ RACCORDS EN PVC ■ RACCORDERIA IN PVC



40537

- Enlace ■ PVC screw
- Raccord PVC ■ Raccordo



Ø 50 HXH PN16



BX PACK 15



8 427370 405372



40538

- Enlace 3P. Macho ■ 3 piece union solvent socket
- Raccord en 3 parties. Macho ■ Raccordo 3P. Maschio.



Ø 50 | 1" 1/2 PN16



BX PACK 20



8 427370 405389



40539

- Enlace 3P. Macho ■ 3 piece union solvent socket
- Raccord en 3 parties. Macho ■ Raccordo 3P. Maschio.



Ø 50 | 2" PN16



BX PACK 15



8 427370 405396



40541

- Válvula antiretorno ■ Check valve
- Valve anti-retour ■ Valvola ritorno



Ø 50 PN16



BX PACK 8



8 427370 405419



40543

- Válvula ■ Valve
- Valve anti-retour ■ Valvola



Ø 50 PN10



BX PACK 6



8 427370 405433



40555

- Raccord curva ■ Curved fitting
- Raccord courbe ■ Raccordo curvo



Ø 50 | 90° PN16



BX PACK 10



8 427370 405556



40590

- Codo ■ PVC elbow ■ Coude ■ Gomito



90° | Ø 50 mm PN16



BX PACK 30



8 427370 405907



40591

- Codo ■ PVC elbow ■ Coude ■ Gomito



45° | Ø 50 mm PN16



BX PACK 18



8 427370 405914



40592

- Te para encolar
- PVC-Tee solvent socket
- Raccord en T à coller
- Raccordo a T da incollare



Ø 50 PN16



BX PACK 12



8 427370 405921



40593

- Racord para encolar
- PVC union solvent socket
- Raccord PVC à coller
- Raccordo da incollare



Ø 50 PN16



BX PACK 18



8 427370 405938



40646

- Válvula, manguito rosca macho
- Ball valve
- Vanne embout mâle
- Valvola, tubo filettato maschio



Ø50 PN10



BX PACK 8



8 427370 406461



40553

- Adhesivo para PVC
- Blue Adhesive for flexible PVC pipes
- Colle PVC
- Adesivo per PVC



250 g



BX PACK 12



8 427370 405532



787104

- Manguera semirígida reforzada, transparente
- Semi-rigid reinforced hose, transparent
- Tuyau semi-rigide renforcé, Transparent
- Tubo semirigido inforzato, trasparente



Ø38 mm. 25 m



PB PACK 1



3 605217 871046



40557

- Tubo PVC semirígido
- Semi-rigid PVC hose
- Couronne PVC semi-rigide
- Tubo PVC semirigido



Ø 50 mm, 25 m



PB PACK 1



8 427370 405570

cleaning

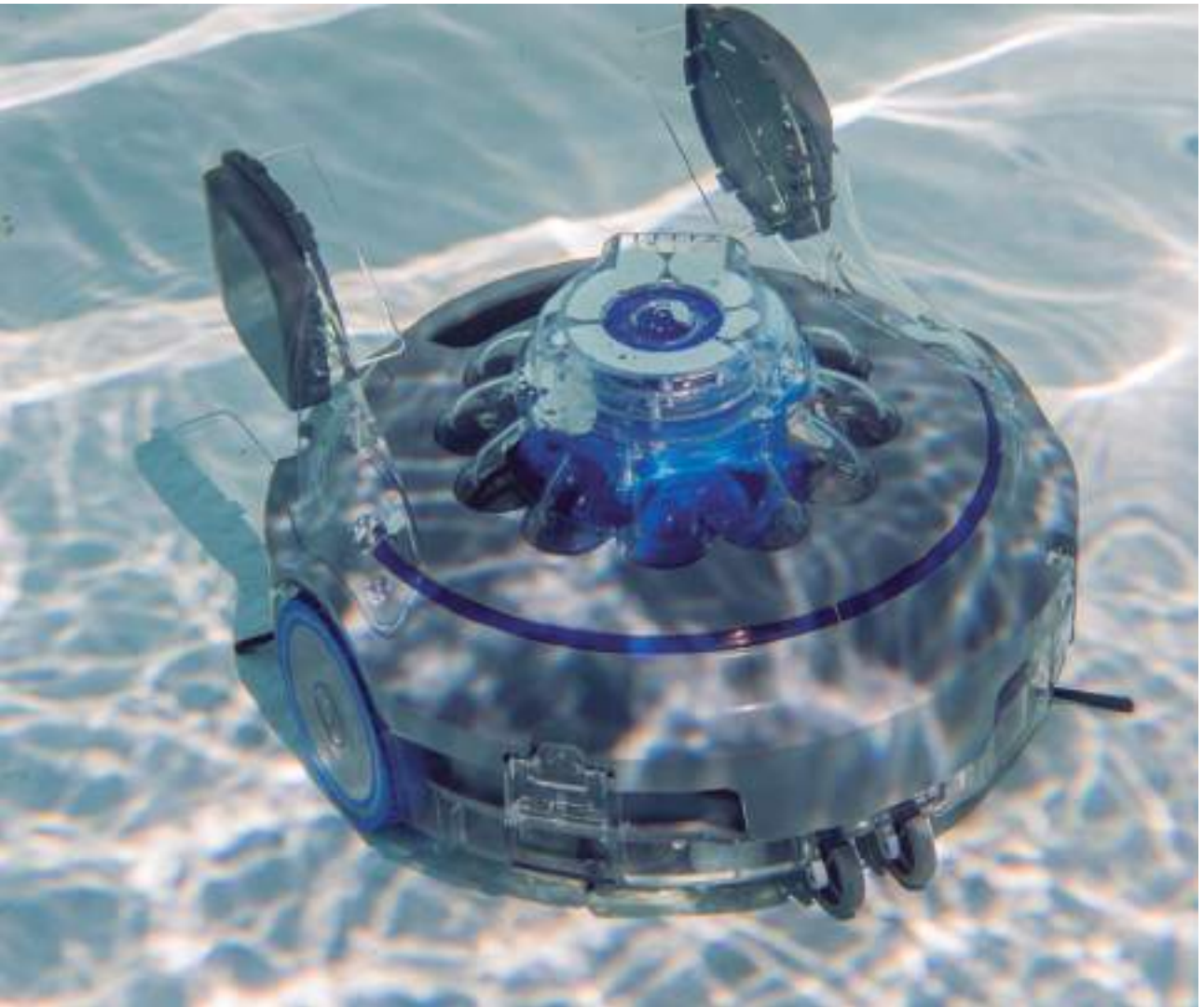

■ Material de limpieza

Robots
 Limpiafondos eléctricos
 Limpiafondos automáticos
 Limpiafondos aspiración
 Kits limpiafondos
 Limpiafondos Ventury
 Gama Graphite
 BOX
 Gama Confort
 Mangos telescópicos
 Recogehojas
 Cepillos
 Esponjas
 Termómetros
 Dosificadores
 Limpiafondos manuales
 Cardboard range
 BOX
 Gama ECO
 BOX
 Protección invierno
 Mangueras flotantes

■ Cleaning material

Robots
 Electric cleaners
 Automatic cleaners
 Vacuum cleaners
 Vacuum cleaners kits
 Ventury vaccum
 Graphite range
 BOX
 Confort range
 Telescopic handles
 Leaf nets and rakes
 Brushes
 Sponges
 Thermometers
 Dispensers
 Vacuum heads
 Cardboard range
 BOX
 ECO range
 BOX
 Winter protection
 Vacuum hoses

152
154
159
161
162
163
164
166
168
170
170
171
171
172
173
173
174
176
178
180
181
182

■ Matériel de nettoyage

Robots
 Nettoyeurs de fond électriques
 Nettoyeurs automatiques
 Nettoyeurs par aspiration
 Kit nettoyeurs
 Aspirateurs de fond ventury
 Gamme Graphite
 BOX
 Gamme Confort
 Manches télescopiques
 Épuisettes
 Brosses
 Eponges
 Thermomètres
 Doseurs
 Balais manuels
 Cardboard range
 BOX
 ECO range
 BOX
 Protection hiver
 Tuyaux flottants

■ Materiale di pulizia

Robots
 Pulitore elettrico
 Puliscifondi automatici
 Pulitore ad aspirazione
 Kit Pulitore fondo
 Puliscifondi Ventury
 Gamma Graphite
 BOX
 Gamma Confort
 Manico telescopico
 Raccoglitori
 Spazzole
 Spugne
 Termometri
 Dosatori
 Puliscifondo manuale
 Cardboard range
 BOX
 ECO range
 BOX
 Protezione inverno
 Tubi galleggianti

- ROBOTS LIMPIAFONDOS ■ POOL ROBOTS
- ROBOTS PISCINE ■ ROBOTS PER PISCINA



NEW
2024

ER 230 | WR000501

- **Robot limpiafondos eléctrico.** Para piscinas enterradas de hasta 9x4m. Limpieza de fondo, paredes y línea de agua en 2h30, con una aspiración potente, una gran cobertura y un uso intuitivo.
- **Robot nettoyeur électrique.** Pour piscines enterrées jusqu'à 9x4m. Nettoyage fond, parois et ligne d'eau en 2h30, avec une aspiration puissante, une large couverture et une utilisation intuitive.
- **Robotic pool cleaner.** For simple inground pools up to 9x4m. Cleans floor, walls, and waterline in 2h30, with a powerful suction a wide coverage and an intuitive use.
- **Robot pulitore elettrico.** Per piscine interrate fino a 9x4m. Pulizia di fondo, pareti e linea d'acqua en 2h30, con un'aspirazione potente, un'ampia copertura e un utilizzo intuitivo.

RBR120 | WETRUNNER XPRT

- **Robot a batería recargable para piscinas elevadas y enterradas** con una inclinación máxima del fondo del 15%. Inalámbrico, recargable en 8 horas. Para piscinas de hasta 12 x 5 m con fondo plano.
- **Battery robot for above and inground pools** with maximum 15% botton slope. Cordless, rechargeable in 8 hours. For pools up to 12 x 5 m with flat floor.
- **Robot à batterie rechargeable pour piscines enterrées et hors sol** avec une pente maximale de 15%. Sans fil, rechargeable en 8heures. Pour piscines de jusqu'à 12 x 5 m avec fond plat.
- **Robot a batteria per piscine fuori terra e interrate** con una pendenza massima del 15%. Cordless, ricaricabile in 8 ore. Per piscine fino a 12 x 5 m con fondo piatto.



	15 m
	floor / walls / waterline - 2,5 h
	36 m ²
	Cyclonic suction
	3 l
	CBX PACK 1

	8 h
	120 min
	60 m ²
	51 W
	13.000 mAh
	11 m/min
	6 m ³ /h
	3 l
	CBX PACK 2



RBR75 | WETRUNNER PLUS

- **Robot a batería recargable para piscinas elevadas y enterradas.** Inalámbrico, recargable en 5 horas. Para piscinas de hasta 10 × 5 m con fondo plano.
- **Battery robot for above and inground pools.** Cordless, rechargeable in 5 hours. For pools up to 10 x 5 m with flat floor.
- **Robot à batterie rechargeable pour piscines enterrées et hors sol.** Sans fil, rechargeable en 5 heures. Pour piscines de jusqu'à 10 × 5 m avec fond plat.
- **Robot a batteria per piscine fuori terra e interrate.** Cordless, ricaricabile in 5 ore. Per piscine fino a 10 x 5 m con fondo piatto.

RBR60 | WETRUNNER

- **Robot a batería recargable para piscinas elevadas.** Inalámbrico, recargable en 4-5 horas. Para piscinas de hasta 7 × 5 m con fondo plano.
- **Battery robot for above ground pools.** Cordless, rechargeable in 4-5 hours. For pools up to 7 x 5 m with flat floor.
- **Robot à batterie rechargeable pour piscines hors sol.** Sans fil, rechargeable en 4-5 heures. Pour piscines de jusqu'à 7 × 5 m avec fond plat.
- **Robot a batteria per piscine fuori terra.** Cordless, ricaricabile in 4-5 ore. Per piscine fino a 7 x 5 m con fondo piatto.

	5 h
	75 min
	50 m ²
	27 W
	5200 mAh
	13 m/min
	4,7 m ³ /h
	2,5 l
	CBX PACK 2

	4/5 h
	60 min
	35 m ²
	27 W
	4000 mAh
	16 m/min
	3,6 m ³ /h
	2 l
	CBX PACK 1

■ material de limpieza ■ cleaning material ■ matériel de nettoyage ■ materiale di pulizia

■ LIMPIAFONDOS ELÉCTRICOS ■ ELECTRIC CLEANERS

■ NETTOYEURS DE FOND ÉLECTRIQUES ■ PULITORE ELETTRICO PER PISCINA

■ Los limpiafondos eléctricos son una solución cómoda y sencilla para la limpieza de la piscina. Son recargables, sin necesidad de cables y muy manejables debido a su tamaño y forma. LA solución para mantener la piscina siempre a punto.

■ Les nettoyeurs de fond électriques sont une solution pratique et simple pour le nettoyage des piscines. Ils sont rechargeables, sans besoin de câbles et très faciles à utiliser en raison de leur taille et de leur forme.

■ Electric cleaners are a convenient and simple solution for cleaning the pool. They are rechargeable, wirelessly and very manageable because of its size and shape.

■ I pulitori elettrici per fondo piscina rappresentano una soluzione comoda e semplice per la pulizia della piscina. Sono ricaricabili, non necessitano di cavi e sono maneggevoli grazie alle loro dimensioni e alla forma.



VCB50P VCB50 VCB10P VCB10 CSPAN CSPA LE75 VCB08 ABS3

	22,2 W	35 W	14,8 W	25 W	10 W	17 W	26,6 W	17 W	10 W
	4,2 m ³ /h	5,4 m ³ /h	2,7 m ³ /h	2,5 m ³ /h	1,5 m ³ /h	1 m ³ /h	5,4 m ³ /h	1 m ³ /h	0,015 m ³ /h
	2,5 l	1,5 l	1,5 l	1,5 l	0,5 l	0,8 l	10 l	1,5 l	0,65 l
	60/90 min	90 min	50/70 min	60 min	30 min	45 min	75 min	-	-
	4/5 h	4/5 h	2/3 h	3 h	5 h	2,5/3 h	3/4 h	-	-
	Lithium	Lithium	Lithium	Lithium	Lithium	Ni Mh	Lithium	8 AA	8 AA
	✓	✓	✓	✓			✓		
	✓	✓	✓	✓			✓		
	✓	✓	✓	✓			✓	✓	✓
		✓	✓		✓	✓		✓	✓
		✓	✓		✓	✓		✓	✓
		✓			✓	✓		✓	✓
		✓			✓	✓		✓	✓



VCB50P | ACTION VAC

■ **Limpiafondos multivelocidad con batería para piscinas y spas.** Ideal para escalones y zonas de difícil acceso. Inalámbrico y recargable (cargador incluido). Para residuos grandes, utilice primero las bolsas filtrantes, para residuos pequeños, introduzca el cartucho.

■ **Multi speed battery cleaner for pools and spas.** Ideal for step and difficult access zones. Cordless, rechargeable (charger included). For big rubbishes, use filter bags first, for fine debris, mount the cartridge into.

■ **Nettoyeur multi-vitesse avec batterie pour piscines et spas.** Idéal pour nettoyer les escaliers et les zones à accès difficile. Sans fil, rechargeable (chargeur inclus). Pour les gros déchets, utilisez d'abord les sacs filtrants, pour les petits déchets, insérez la cartouche.

■ **Puliscifondo a batteria multi velocità per piscine e spa.** Ideale per gradini e zone di difficile accesso. Cordless, ricaricabile (caricatore incluso). Per detriti grossolani, utilizzare prima i sacchetti filtro, per i detriti fini, montare la cartuccia.

VCB10P | SUPER VAC

■ **Limpiafondos multivelocidad con batería para piscinas enterradas y elevadas.** Ideal para escalones y zonas de difícil acceso. Inalámbrico, recargable (cargador incluido). Para residuos grandes, utilice primero las bolsas filtrantes, para residuos pequeños, introduzca el cartucho.

■ **Multi speed battery cleaner for above and inground pools.** Cordless, rechargeable (charger included). For big rubbishes, use filter bags first, for fine debris, mount the cartridge into.

■ **Nettoyeur multi-vitesse avec batterie pour piscines enterrées et hors sol.** Idéal pour nettoyer les escaliers et les zones à accès difficile. Sans fil, rechargeable (chargeur inclus). Pour les gros déchets, utilisez d'abord les sacs filtrants, pour les petits déchets, insérez la cartouche.

■ **Puliscifondo a batteria multi velocità per piscine fuori terra e interrate.** Ideale per gradini e zone di difficile accesso. Cordless, ricaricabile (caricatore incluso). Per detriti grossolani, utilizzare prima i sacchetti filtro, per i detriti fini, montare la cartuccia.

	22,2 W
	4,2 m³/h
	2,5 l
	60/90 min
	4/5 h
	Lithium
	CBX PACK 1
	8 4 12081 313061

	14,8 W
	2,7 m³/h
	1,5 l
	50/70 min
	2/3 h
	Lithium
	CBX PACK 2
	8 4 12081 313054

■material de limpezia ■cleaning material ■matériel de nettoyage ■materiale di pulizia



VCB50 | ELECTRIC VAC PLUS

■ **Limpiafondos eléctrico autónomo.** Se puede utilizar con su propio mango o conectado a un mango telescópico estándar para facilitar su uso en piscinas más profundas. Sin cables. Incluye 3 baterías recargables litio. Ligero, fácil de manejar.

■ **Multi speed battery cleaner for pools and spas.** Ideal for step and difficult access zones. Cordless, rechargeable (charger included). For big rubbishes, use filter bags first, for fine debris, mount the cartridge into.

■ **Nettoyeur multi-vitesse avec batterie pour piscines et spas.** Idéal pour nettoyer les escaliers et les zones à accès difficile. Sans fil, rechargeable (chargeur inclus). Pour les gros déchets, utilisez d'abord les sacs filtrants, pour les petits déchets, insérez la cartouche.

■ **Puliscifondo a batteria multi velocità per piscina e spa.** Ideale per gradini e zone di difficile accesso. Cordless, ricaricabile (caricatore incluso). Per detriti grossolani, utilizzare prima i sacchetti filtro, per i detriti fini, montare la cartuccia.



VCB10 | ELECTRIC VAC

■ **Limpiafondos eléctrico para piscinas enterradas,** limpia las escaleras y esquinas. Posee un depósito removible de gran capacidad e incorpora un filtro que retiene partículas de pequeño tamaño. Recargable y sin cables. Posibilidad de uso conectándolo a una pértiga (incluida).

■ **Electric cleaner for in-ground pools,** cleans stairs and corners. It has a large capacity removable tank and includes a filter to retain small-size particles. Rechargeable and without cables. Possibilities of use with its own handle or connected to a pole (included).

■ **Nettoyeurs pour les piscines enterrées.** Il nettoie les escaliers et les angles. Il est muni d'un réservoir amovible de grande capacité et il incorpore un filtre qui retient les particules de petite taille. Rechargeable et sans câbles. Il peut être utilisé connecté à une pôle (inclus).

■ **Pulitore elettrico per piscine interrate,** pulisce le scalette e gli angoli che il pulitore automatico non riesce a raggiungere. È dotato di un capiente serbatoio removibile e di un filtro in grado di trattenere le particelle più piccole. Ricaricabile e senza fili. Palo incluso.

	35 W
	5,4 m ³ /h
	1,5 l
	90 min
	4/5 h
	Lithium
	CBX PACK 1
	8 4 12081 272528

	25 W
	2,5 m ³ /h
	1,5 l
	60 min
	3 h
	Lithium
	CBX PACK 2
	8 4 12081 263298



CSPA | HEALTH VAC

- **Limpiafondos para piscinas y spas con mango. Recargable y sin cables.** Posibilidad de uso con su propio mango o conectado a una pértiga. Ligero y manejable.
- **Pool and spa vac. Rechargeable and without cables.** Possibilities of use with its own handle or connected to a pole. Lightweight and easy to use.
- **Nettoyeur de fond pour piscines et spas.** Rechargeable et sans câbles. Il peut être utilisé avec sa poignée ou bien connecté à une perche. Léger et facile à manipuler.
- **Pulitore per fondo piscina e spa.** Ricaricabile e senza fili. Può essere utilizzato con il manico in dotazione o collegato a un'asta.



NEW
2024



CSPAN | HEALTH VAC PLUS

- **Limpiafondos para piscinas y spas con mango. Recargable y sin cables.** Posibilidad de uso con su propio mango o conectado a una pértiga. Ligero y manejable. Incluye un pequeño cepillo.
- **Pool and spa vac. Rechargeable and without cables.** Possibilities of use with its own handle or connected to a pole. Lightweight and easy to use. Small brush included.
- **Nettoyeur de fond pour piscines et spas.** Rechargeable et sans câbles. Il peut être utilisé avec sa poignée ou bien connecté à une perche. Léger et facile à manipuler. Petite brosse incluse.
- **Pulitore per fondo piscina e spa.** Ricaricabile e senza fili. Può essere utilizzato con il manico in dotazione o collegato a un'asta. Piccola spazzola inclusa.

	17 W
	1 m ³ /h
	0,8 l
	45 min
	2,5/3 h
	Ni Mh
	CBX PACK 2

	10 W
	1,5 m ³ /h
	0,5 l
	30 min
	5 h
	Lithium
	CBX PACK 2

■material de limpezia ■cleaning material ■matériel de nettoyage ■materiale di pulizia



NEW
2024



LE75 | LEAF EATER

■ **Aspirador de hojas a batería.** Recargable y sin cables. Se conecta a una pértiga telescópica estándar. Gran capacidad de filtrado y gran potencia de aspiración.

■ **Leaf eater battery cleaner.** Rechargeable and without cables. To be connected to standard telescopic poles. Extra big filter capacity. High suction power.

■ **Nettoyeur de feuilles à batterie.** Rechargeable et sans câbles. Se raccorde aux perches télescopiques standard. Grande capacité de filtrage et puissance d'aspiration élevée.

■ **Pulitore per foglie a batteria.** Ricaricabile e senza fili. Da collegare alle aste telescopiche standard. Grande capacità del filtro. Elevata potenza di aspirazione.



26,6 W



5,4 m³/h



10 l



75 min



3/4 h



Lithium



CBX PACK 1



8 412081 290065

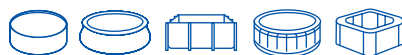

VCB08 | STICK VAC

■ **Limpiafondos para piscinas y spas.** Recargable y sin cables. Posibilidad de uso con su propio mango o conectado a una pértiga. Ligero y manejable.

■ **Pool and spa vac.** Rechargeable and without cables. Possibilities of use with its own handle or connected to a pole. Lightweight and easy to use.

■ **Nettoyeur de fond pour piscines et spas.** Rechargeable et sans câbles. Il peut être utilisé avec sa poignée ou bien connecté à une perche. Léger et facile à manipuler.

■ **Pulitore per fondo piscina e spa.** Ricaricabile e senza fili. Può essere utilizzato con il manico in dotazione o collegato a un'asta.



17 W



1 m³/h



1,5 l



8 AA



CBX PACK 6



8 412081 272535



ABS3 | POLE VAC

■ **Limpiafondos de batería para piscinas y spas con mango telescópico.** Sin cables. Pértiga extensible de 133 cm incluida. Ligero y manejable.

■ **Battery powered pool and spa cleaner with telescopic handle.** No cables. Extendible handle of 133 cm included. Light-weight and easy to handle.

■ **Nettoyeur de fond à batterie pour piscines et spas avec manche télescopique.** Sans câbles. Perche extensible de 133 cm incluse. Léger et maniable.

■ **Puliscifondo a batteria per piscina e spa con manico telescópico.** Senza fili. Prolunga per manico estensibile da 133 cm inclusa. Leggero e maneggevole.



10 W



0,015 m³/h



0,65 l



8 AA



CBX PACK 6



8 412081 302751

■ LIMPIAFONDOS AUTOMÁTICOS ■ AUTOMATIC CLEANERS
 ■ NETTOYEURS AUTOMATIQUES ■ PULISCIFONDI AUTOMATICI



19007 | PROFESSIONAL VAC

- **Limpiafondos automático de membrana.** Limpia el fondo y las paredes de cualquier piscina. Funciona con sistemas de filtración de una potencia mínima de 0,33CV.
- **Automatic pool cleaner with membrane system.** The Professional Vac cleans the bottom and walls of your pool. Works with 0,33 hp minimum.
- **Nettoyeur automatique avec système unique de membrane.** Nettoie le fond et les parois de la piscine. Il fonctionne avec des systèmes de filtration d'une puissance minimum de 0,33cv.
- **Puliscifondo automatico con sistema a membrana.** Il Professional Vac pulisce il fondo e le pareti della piscina. Funziona con sistemi di filtrazione che hanno una potenza minima di 0,33cv.



90397 | SILENCE VAC

- **Limpiafondos automático más silencioso.** Limpia el fondo y las paredes. Funciona con sistemas de filtración de una potencia mínima de ½cv y máxima de 1½cv.
- **Automatic pool cleaner quieter than the traditional "hammer" systems.** Cleans the bottom and walls. Works with ½ hp min. and 1½hp max power filtration systems.
- **Nettoyeur automatique plus silencieux que les systèmes traditionnels à "marteau".** Nettoie le fond et les parois. Il fonctionne avec des systèmes de filtration d'une puissance min. de ½cv et max. de 1CV 1/2.
- **Puliscifondo automatico più silenzioso.** Il pulisce il fondo e le pareti della piscina. Funziona con sistemi di filtrazione che hanno una potenza minima di ½cv e massima di 1½cv.



19001 | CLASSIC VAC

- **Limpiafondos automático para piscinas enterradas y elevadas** dotadas de un equipo de filtración con una bomba de una potencia mínima de 3/4 cv.
- **Automatic pool cleaner for in ground and above ground pools** equipped with filtering equipment with a minimum power pump of 3/4 hp.
- **Nettoyeur automatique pour piscines enterrées et hors-sol** équipées d'une filtration avec une pompe d'une puissance minimum de 3/4cv.
- **Puliscifondo interrate e fuori terra** dotate di un sistema di filtrazione con una potenza minima di 3/4 cv.



9,6 m - Ø 38



min. 1/3 CV



CBX PACK 1



8 427370 190070



9,6 m - Ø 38



min. ½ CV - max. 1 ½ CV



CBX PACK 2



8 427370 903977



8 m - Ø 38



min. 3/4 CV



CBX PACK 1



8 427370 190018



- Cómo utilizar un limpiafondos automático
- How to use an automatic pool cleaner
- Comment utiliser un nettoyeur automatique de piscine
- Come utilizzare un pulitore automatico

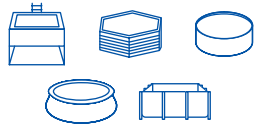

90399 | WIKI VAC

- **Limpiafondos automático para piscinas autoportantes y elevadas.** Funciona con equipos de filtración de baja potencia. Con prefiltro exclusivo que permite proteger el cartucho y la filtración.
- **Automatic pool cleaner for above ground pools.** Works with low-power filtering equipment. With unique pre-filter which protects the cartridge and filtration.
- **Nettoyeur automatique pour piscines autoportantes et hors-sol.** Il fonctionne avec des systèmes de filtration de très faible puissance. Il dispose d'un pré-filtre exclusif qui protège la cartouche et la filtration.
- **Puliscifondo per piscine autoportanti e fuoriterra.** Funziona con un sistema di filtrazione a bassa potenza. Con prefiltro esclusivo che permette una maggior cura della cartuccia e della filtrazione.



AR20682 | SMALL CONFORT

- **Limpiafondos automático por aspiración.** Se conecta directamente al skimmer y es compatible con bombas a partir de 1/3CV.
- **Automatic suction pool cleaner** that is directly connected to the skimmer. Compatible with pumps from 1/3HP.
- **Nettoyeur de fond automatique par aspiration.** Il se branche directement sur le skimmer et il est compatible avec des pompes à partir de 1/3 de CV.
- **Puliscifondo automatico ad aspirazione.** Si collega direttamente allo skimmer ed è compatibile con pompe a partire da 1/3CV.



PFAC17

- **Prefiltro para limpiafondos de aspiración.** Conector de manguera giratorio incluido. Contenedor transparente que permite saber cuándo está lleno. Capacidad de 1,7 litros.
- **Pre-filter to be used with suction cleaners.** Big capacity prefilter. Swivel connector included. Clear container allows to see when basket is full. 1,7 liters capacity.
- **Pré-filtre pour aspirateur.** Raccord de tuyau rotatif inclus. Contenant transparent qui vous permet de savoir quand il est plein. Capacité de 1,7 litres.
- **Prefiltro per Puliscifondo.** Connettore per tubo flessibile incluso. Contenitore trasparente che ti consente di sapere quando è pieno. Capacità di 1,7 litri.



6 m - Ø 32



min. 0,1 CV



CBX PACK 2



8 427370 90399 1



6 m - Ø 32



min. 1/3 CV



CBX PACK 4



8 412081 23228 7



1,7 l



CBX PACK 4



8 412081 30274 4

■ LIMPIAFONDOS DE ASPIRACIÓN MANUAL ■ VACUUM CLEANERS
 ■ NETTOYEURS À ASPIRATION MANUELLE ■ PULITORI ASPIRAZIONE MANUALE



AR20637 | MEDIUM VAC

- **Kit de mantenimiento para piscinas autoportantes o elevadas.** Con dos boquillas, una de ellas con cepillo.
- **Maintenance kit for inflatable or above ground pools.** The pool cleaner includes: two suction nozzles, one with a brush.
- **Kit d'entretien pour piscines autoportantes ou hors-sol.** Contient: un aspirateur de fond à aspiration manuelle qui inclut deux embouts.
- **Kit di mantenimento per piscine autoportanti o fuori terra.** Contiene due aspiratori, uno con pennello



9 m - Ø 32



CBX PACK 6



O8011A | LITTLE VAC

- **Kit de mantenimiento para piscinas autoportantes o elevadas.**
- **Maintenance kit for inflatable or above ground pools.**
- **NettoyeurKit d'entretien pour piscines autoportantes ou hors-sol.**
- **Kit di mantenimento per piscine autoportanti o fuori terra.**



5 m - Ø 32



CBX PACK 6



■ CARTUCHOS ■ CARTRIDGES ■ CARTOUCHES ■ CARTUCCIA



CCSPAN

CSPAN

CBX PACK 6



CVCB50P

VCB50P

CBX PACK 6



CVCB10P

VCB10P

CBX PACK 6



CRBR75

RBR75

CBX PACK 6



CRBR120

RBR120

CBX PACK 6



NEW
2024



■ material de limpeza ■ cleaning material ■ matériel de nettoyage ■ materiale di pulizia

■ KITS LIMPIAFONDOS ■ VACUUM CLEANER KITS
 ■ KITS DE NETTOYAGE ■ KIT PULITORI FONDO AD ASPIRAZIONE



AR20641

- **Kit mantenimiento piscinas:** Limpiafondos + pértiga 3 secciones + recogedor de fondo + termómetro flotante + dosificador oval + cepillo para liner + manguera 6m + bote de tiras reactivas (tester).
- **Pool maintenance kit:** Bottom cleaner + 3 section pole + leaf rake + floating thermometer + oval dispenser + brush for liner + 6m hose + can of reactive test strips (tester).
- **Pack d'entretien comprenant:** un nettoyeur de fond + un manche télescopique 3 sections + une épuisette de fond + un thermomètre flottant + un diffuseur de chlore pour galets de 200gr + une brosse pour liner + un tuyau de 6m + une boîte de bandelettes de test.
- **Kit di mantenimento per piscine:** Puliscifondi + pertica 3 sezioni + raccoglitore di fondo + termometro galleggiante + dosatore ovale + spazzola per liner + 6m tubo + strisce di analisi.



CBX PACK 2



AR2064

- **Kit mantenimiento piscinas:** limpiafondos + pértiga 3x1,20 m + manguera 6 m.
- **Pool maintenance kit:** Vacuum head kit + handle 3x1,20 m + 6 m hose.
- **Kit d'entretien comprenant :** une tête de balai avec brosses latérales + un manche télescopique 3,60 m (3x1,20 m) + un tuyau de 6 m
- **Kit di mantenimento per piscine:** puliscifondo + pertica 3,60 m (3x1,20 m) + tubo 6 m



CBX PACK 4



KMA05

- **Kit mantenimiento piscinas:** analizador pH/Cl, cepillo 45 cm, recogehojas superficie, termómetro y limpiafondos.
- **Pool maintenance kit:** pH/Cl Test kit, 45 cm Brush, leaf net, thermometer and Vacuum head.
- **Kit d'entretien pour piscines comprenant :** une trousse d'analyse pH/Cl, une brosse 45 cm, une épuisette de surface, un thermomètre et une tête de balai manuel.
- **Kit di mantenimento per piscine:** analizzatore ph/cl, spazzola 45 cm, raccoglitore di superficie, termometro e puliscifondo.



CS PACK 6



KMSPA

- **Kit mantenimiento para spa hinchable o rígido.** Incluye: Recogehojas, cepillo, esponja de la línea de flotación, pértiga.
- **Maintenance kit for Inflatable and rigid spas.** Includes: leaf skimmer, brush, water line cleaner sponge, pole
- **Kit de nettoyage pour spa gonflable ou rigide comprenant :** une épuisette, une brosse, une éponge pour la ligne d'eau et un manche télescopique.
- **Mantenimento per spa gonfiabili o parete rigida.** Include: raccoglitore, spazzola, spugne per la linea di galleggiamento, pertica



CS PACK 6



■ LIMPIAFONDOS VENTURY ■ VENTURY VACUUM
 ■ ASPIRATEURS DE FOND VENTURY ■ PULISCIFONDI VENTURY



08050

- **Kit piscina autoportante:** analizador pH/Cl, cepillo, recogehojas de superficie, mango 1,20 m (3 tramos) termómetro tubular, dosificador y jet vac ventury.
- **Special inflatable pool kit:** pH/chlorine test kit, brush, leaf net, tubular thermometer, 1,20 m handle (3 sections), floating dispenser and ventury vacuum.
- **Kit spécial piscine autoportante:** trousse d'analyse pH/Cl, brosse, époussette de surface, manche 1,20 m (3 parties), thermomètre tubulaire, doseur pastilles rétractable and jet vac ventury.
- **Kit speciale per piscina autoportante:** analizzatore pH/Cl, spazzola, Raccogliatore di superficie, manico 1,20 m (3 sezioni) termometro tubolare, dosatore e aspiratore jet vac ventury.



CS PACK 6



784880

- **Kit manenimiento:** Mango telescópico 120cm, cepillo línea de agua, recogehojas de superficie, termómetro, cabezal limpiafondos medialuna, limpiafondos tipo ventury, dosificador de cloro.
- **Maintenance kit:** telescopic pole 120cm, scrub brush, leaf skimmer, floating thermometer, vacuum venturi + brush, small chlorine dispenser.
- **Kit entretien:** Manche télescopique 120cm, brosse ligne d'eau, epoussette de surface, thermomètre flottant, tête de balai demi-lune, nettoyeur micro-venturi, diffuseur de chlore petit modèle.
- **Kit manutenzione:** Manico telescopico 120 cm, spazzola per linea d'acqua, raccogli foglie da superficie, termometro galleggiante, testa puliscifondo, Puliscifondi Micro-Ventury, diffusore per cloro.



CS PACK 6



90111

- Limpiafondos Micro-Ventury.
- Micro-Ventury Vacuum.
- Nettoyeur Micro-Venturi.
- Puliscifondi Micro-Ventury.



DIS PACK 8



772794

- Limpiafondos media luna venturi + bolsa.
- Jet vac with brush and bag.
- Aspirateur brosse demi-lune venturi + sac.
- Puliscifondi venturi con spazzola a mezzaluna.



CS PACK 6



Y12

- 2 filtros para limpiafondos ventury
- 2 filters for ventury bottom cleaner.
- 2 sacs filtrants pour aspirateur de fond Ventury,
- 2 filtri per puliscifondo venturi



CS PACK 50



770344

- Bolsa de recambio limpiafondos venturi pequeño
- Replacement bag for jet vac
- Sac de rechange pour aspirateur venturi petit modèle
- Sacca di ricambio per aspiratore venturi piccolo



PB PACK 24



■ material de limpeză ■ cleaning material ■ matériel de nettoyage ■ materiale di pulizia

■ SERIE GRAPHITE ■ GRAPHITE SERIE ■ GAMME GRAPHITE ■ GAMMA GRAPHITE



LSP40

- Recogehojas de superficie
- Leaf net
- Épuisette de surface
- Raccogliatore di superficie



CB PACK 6



LRP40

- Recogehojas de fondo
- Leaf rake
- Épuisette de fond
- Raccogliatore di fondo



CB PACK 6



VHTP40

- Limpiafondos triangular
- Triangular suction pool cleaner
- Balai triangulaire
- Puliscifondo triangolare



CB PACK 6



VHRP40

- Limpiafondos rectangular
- Rectangular suction pool cleaner
- Balai rectangulaire
- Puliscifondo rettangolare



CB PACK 6



THP24

- Termómetro digital flotante
- Floating digital thermometer
- Thermomètre digital flottant
- Termometro digitale galleggiante



CS PACK 9



TPP360

- Mango telescópico de aluminio
- Telescopic aluminium handle
- Manche télescopique argenté
- Manico telescopico argentato



CB PACK 6



Graphite
SERIES



WBP45

- Cepillo 45 cm
- 45 cm brushes
- Brosse 45 cm
- Spazzole 45 cm



CB PACK 6



8 412081 302812



WBP25

- Cepillo 25 cm
- 25 cm brushes
- Brosse 25 cm
- Spazzole 25 cm



CB PACK 6



8 412081 302829



FDP250

- Dosificador flotante pastillas 250gr
- Tablets floating dispenser 250gr
- Doseur flottant pour pastilles 250 g
- Dosatore galleggiante pastiglie da 250 g



CB PACK 12



8 412081 302843



FDP20

- Dosificador flotante pastillas 20gr
- Tablets floating dispenser 20gr
- Doseur flottant pour pastilles 20 g
- Dosatore galleggiante pastiglie da 20 g



CB PACK 12



8 412081 302850



HBP20

- Cepillo manual multifunción
- Multi-function manual brush
- Brosse manuelle multifonction
- Spazzola manuale multifunzione



CB PACK 6



8 412081 302805

■ material de limpieza ■ cleaning material ■ matériel de nettoyage ■ materiale di pulizia

BGRA10

- Box de material de limpieza
- Cleaning material box
- Matériel de nettoyage box
- Box di materiale di pulizia



DIS PACK 1



Graphite
SERIES



				
FDP20	1	<ul style="list-style-type: none"> ■ Dosificador 20g ■ Dispenser 20g ■ Diffuseur 20g ■ Dosatore 20g 	12	
HBP20	2	<ul style="list-style-type: none"> ■ Cepillo manual ■ Hand brush ■ Brosse à main ■ Spazzola manuale 	6	
WBP25	3	<ul style="list-style-type: none"> ■ Cepillo 25 cm ■ 25 cm brush ■ Brosse 25 cm ■ Spazzola 25 cm 	6	
FDP250	4	<ul style="list-style-type: none"> ■ Dosificador 250g ■ Dispenser 250g ■ Diffuseur 250g ■ Dosatore 250g 	12	
WBP45	5	<ul style="list-style-type: none"> ■ Cepillo 45 cm ■ 45 cm brush ■ Brosse 45 cm ■ Spazzola 45 cm 	6	
LRP40	6	<ul style="list-style-type: none"> ■ Recogehojas fondo ■ Leaf rake ■ Épuisette de fond ■ Raccogliore di fondo 	6	
LSP40	7	<ul style="list-style-type: none"> ■ Recogehojas superficie ■ Leaf net ■ Épuisette de surface ■ Raccogliore superficie 	6	
VHRP40	8	<ul style="list-style-type: none"> ■ Limpiafondos rectangular ■ Rectangular vacuum head ■ Tête de balai rectangulaire ■ Puliscifondo rettangolare 	6	
THP24	9	<ul style="list-style-type: none"> ■ Termómetros ■ Thermometer ■ Thermomètre ■ Termometro 	9	
VHTP40	10	<ul style="list-style-type: none"> ■ Limpiafondos triangular ■ Triangular vacuum head ■ Tête de balai triangulaire ■ Puliscifondo triangolare 	6	

■ material de limpeză ■ cleaning material ■ matériel de nettoyage ■ materiale di pulizia

■ GAMA CONFORT ■ CONFORT RANGE
 ■ GAMME CONFORT ■ GAMMA CONFORT



40030N

- Recogehojas de superficie
- Leaf net
- Épuisette de surface
- Raccogliatore di superficie



DIS PACK 12

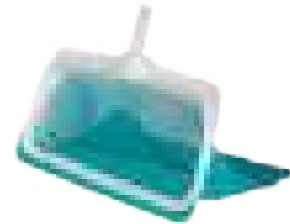

40032N

- Recogehojas de fondo
- Leaf rake
- Épuisette de fond
- Raccogliatore di fondo



DIS PACK 12



RHSALN

- Recogehojas de superficie aluminio
- Aluminium leaf net
- Épuisette de surface aluminium
- Raccogliatore di superficie alluminio



DIS PACK 12



RHFALN

- Recogehojas de fondo aluminio
- Aluminium leaf rake
- Épuisette de fond aluminium
- Raccogliatore di fondo alluminio



DIS PACK 12



TTUFO

- Termómetro UFO
- UFO thermometer
- Thermomètre UFO
- Termometro UFO



DIS PACK 12



BHM5

- Colgador metálico.
- Metalic hanger.
- Support mural en métal.
- Portautensili metallico.



BX PACK 6

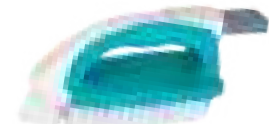

40040N

- Cepillo manual multifunción
- Multifunctional manual brush
- Brosse manuelle multifonction
- Spazzola manuale multifunzione



DIS PACK 12





40041N

- Cepillo 50 cm
- 50 cm brushes
- Brosse 50 cm
- Spazzole 50 cm



DIS PACK 12



40016N

- Limpiafondos triangular rotativo con cepillos
- Triangular swivelling vac head with brushes
- Tête de balai triangulaire rotative avec brosses
- Puliscifondo triangolare rotante con spazzole



DIS PACK 4



40041SN

- Cepillo 35 cm
- 35 cm brushes
- Brosse 35 cm
- Spazzole 35 cm



DIS PACK 12



40017N

- Limpiafondos ovalado rotativo con cepillos
- Triangular swivelling vac head with brushes
- Tête de balai triangulaire rotative avec brosses
- Puliscifondo triangolare rotante con spazzole



DIS PACK 6



40046N

- Cepillo aluminio 50 cm
- 50 cm aluminium brush
- Brosse aluminium 50 cm
- Spazzole alluminio 50 cm



DIS PACK 12



40018N

- Limpiafondos manual 8 ruedas y cepillos laterales
- Swivelling vacuum head 8 wheels and lateral brushess
- Tête de balai manuel 8 roues avec brosses latérales
- Puliscifondo manuale con 8 ruote e spazzole laterali



DIS PACK 6



■ material de limpeză ■ cleaning material ■ matériel de nettoyage ■ materiale di pulizia

■ MANGOS TELESCÓPICOS ■ TELESCOPIC HANDLES
■ MANCHES TÉLESCOPIQUES ■ MANICO TELESCOPICO



40014

- Mango telescópico de aluminio.
- Telescopic aluminium handle.
- Manche télescopique argenté.
- Manico telescópico argentato.



3,60 m (3 x 1,20 m)



BX PACK 12



8 427370 400148



40011

- Mango telescópico de aluminio.
- Telescopic aluminium handle.
- Manche télescopique argenté.
- Manico telescópico argentato.



4,80 m (2 x 2,40 m)



BX PACK 10



8 427370 400117



40010

- Mango telescópico de aluminio.
- Telescopic aluminium handle.
- Manche télescopique argenté.
- Manico telescópico argentato.



3,60 m (2 x 1,80 m)



BX PACK 10



8 427370 400100



40013

- Mango telescópico de aluminio.
- Telescopic aluminium handle.
- Manche télescopique argenté.
- Manico telescópico argentato.



2,40 m (2 x 1,20 m)



BX PACK 20



8 427370 400131

■ RECOGEHOJAS ■ LEAF NETS AND RAKES ■ ÉPUISETTES ■ RACCOGLITORI



40031F

- Recogehojas de fondo + mango telescópico
- Leaf rake + telescopic handle
- Épuiette de fond + manche télescopique
- Raccoglitore di fondo + Manico telescópico



CB PACK 12



8 412081 268866



40031

- Recogehojas de superficie + mango telescópico
- Leaf net + telescopic handle
- Épuiette de surface + manche télescopique
- Raccoglitore di superficie + Manico telescópico



CB PACK 12



8 427370 400315

■ CEPILLOS & ESPONJAS ■ BRUSHES & SPONGES
 ■ BROSSES & EPONGES ■ SPAZZOLE & SPUGNE



CAA25

- Cepillo aluminio para eliminar algas
- Aluminium brush to eliminate the algae
- Brosse en aluminium pour éliminer les algues.
- Spazzola alluminio per eliminare le alghe



DIS PACK 16



40802

- Cepillo aspirante
- Vacuum brush
- Brosse aspirante
- Spazzola per aspirare



DIS PACK 10



40806

- Cepillo aspirador limpiaesquinas.
- Corners-cleaner vacuum brush
- Brosse aspirante d'angle
- Spazzola per aspirare angoli



DIS PACK 18



770334

- Esponja para la línea de flotación.
- Water line cleaner sponge.
- Eponge à main ligne d'eau
- Spugne per la linea di galleggiamento



CB PACK 6



GFL5

- Guante con esponja para limpiar la línea de flotación.
- Aluminium brush to eliminate the algae.
- Gant avec éponge pour le nettoyage de la ligne de flottaison sur le liner.
- Guanto in spugna per pulire la linea di galleggiamento.



CB PACK 24



PGL4

- Esponjas mágicas para la línea de flotación. 4 unidades.
- Water line cleaner magic sponges. 4 units
- Eponges magiques nettoyant la ligne d'eau. 4 unités.
- Spugne magiche per la linea di galleggiamento. 4 unità.



DIS PACK 12



■ material de limpieza ■ cleaning material ■ matériel de nettoyage ■ materiale di pulizia

■ TERMÓMETROS ■ THERMOMETERS
■ THERMOMÈTRES ■ TERMOMETRO



TBF20

- Termómetro pez payaso
- Clown fish thermometer
- Thermomètre de type poisson clown
- Termometro pesce pagliaccio.



BXL PACK 12



40055

- Termómetro bola.
- Ball thermometer.
- Thermomètre boule.
- Termometro a sfera.



CB PACK 15



40054

- Termómetro boya.
- Buoy thermometer.
- Thermomètre bouée.
- Termometro galleggiante.



DIS PACK 10



40051

- Termómetro tubular flotante.
- Tubular floating thermometer.
- Thermomètre flottant tubulaire.
- Termometro tubolare.



DIS PACK 18



40050

- Termómetro "Big". Doble lectura.
- "Big" thermometer. Double reading.
- Thermomètre "Big". Double lecture
- Termometro "Big". Doppio lettura



CS PACK 12



770326

- Termómetro animal.
- Animals thermometer.
- Thermomètre animaux.
- Termometro animale.



DIS PACK 12



■ DOSIFICADORES ■ DISPENSERS ■ DIFFUSEURS DE CHLORE ■ DOSATORI



40070

- **Combi Thermo-dosificador:** Capacidad 1,5 Kg (pastillas de 20 a 500 g) + Termómetro + Visor de consumo de producto.
- **Combi Thermo-dosifier:** Dosifier capacity 1,5 kg (20 to 500 g tablets) + Thermometer + Consumption Viewer.
- **Combi Thermo-doseur:** doseur avec une capacité de 1,5 Kg (pastilles de 20 à 500 g) + thermomètre + témoin de consommation du produit.
- **Combi Thermo-Dosatore:** Capacità 1,5 kg (Tavolette da 20 a 500 g) + Termometro + Controllo livello del prodotto.



DIS PACK 5



DCT20

- **Combi Thermo-dosificador:** dosificador de pastillas de 20 g + Termómetro + Visor de consumo de producto.
- **Combi Thermo-dosifier:** Dosifier 20 g tablets + Thermometer + Product Consumption Viewer.
- **Combi Thermo-doseur:** doseur pour pastilles de 20 g + thermomètre + témoin de consommation du produit.
- **Combi Thermo:** doseur pour pastilles de 20 g + thermomètre + témoin de consommation du produit.



DIS PACK 36



40071

- Dosificador flotante. Capacidad: 7 pastillas de 20 g.
- Floating dispenser. Capacity: 7 tablets 20 g.
- Doseur flottant. Capacité 7 pastilles de 20 g.
- Dosatore galleggiante. Capacità 7 pastiglie da 20 g.



DIS PACK 30



■ LIMPIAFONDOS MANUALES ■ VACUUM HEADS
■ BALAIS MANUELS ■ PULISCIFONDO MANUALI



40022

- Limpiafondos de aluminio
- Aluminium vac head
- Balai en aluminium
- Alluminio puliscifondo



BX PACK 6



40092

- Empuñadura clip Ø28 mm
- Clip handle Ø28 mm
- Poignée clip Ø28mm
- Impugnatura clip Ø28 mm



DIS PACK 12



■ CARDBOARD RANGE



772804

- Recogehojas de superficie clásico.
- Classic leaf net.
- Épuisette de surface classique.
- Raccogliatore di superficie classico.



CB PACK 12



772868

- Recogehojas de superficie profesional.
- Professional leaf net
- Épuisette de surface professionnelle.
- Raccogliatore di superficie professionale.



CB PACK 12



777580

- Recogehojas de fondo clásico.
- Classic leaf rake.
- Épuisette de fond classique.
- Raccogliatore di fondo classico.



CB PACK 12



772872

- Recogehojas de fondo profesional.
- Professional leaf rake.
- Épuisette de fond professionnelle.
- Raccogliatore di fondo professionale.



CB PACK 12



772869

- Recogehojas de superficie + mango aluminio.
- Leaf net + aluminium telescopic handle.
- Épuisette de surface + manche en aluminium.
- Raccogliatore di superficie + Manico telescopico.



CS PACK 12





777584

- Limpiafondos triangular rotativo con cepillos
- Triangular swivelling vac head with brushes
- Tête de balai triangulaire rotative avec brosses
- Puliscifondo triangolare rotante con spazzole



CB PACK 6



3 605217 775849



770306

- Limpiafondos ovalado rotativo con cepillos
- Oval swivelling vac head with brushes
- Tête de balai ovale rotative avec brosses
- Puliscifondo ovale rotante con spazzole



CB PACK 6



3 605217 703064



777970

- Limpiafondos media luna clásico
- Half moon vacuum head classic
- Tête de balai demi-lune classique
- Puliscifondo mezza luna



CS PACK 6



3 605217 779700



777573

- Limpiafondos rotativo 8 ruedas con cepillos laterales
- Swivelling vacuum head 8 wheels with lateral brushes
- Tête de balai rotative 8 roues avec brosses latérales
- Puliscifondo con 8 ruotes e spazzole laterali



CS PACK 6



3 605217 775733



772877

- Cepillo aluminio gran formato 45 cm
- Big format 45 cm aluminium brush
- Brosse aluminium grand format 45 cm
- Spazzole alluminio gran formato 45 cm



CB PACK 6



3 605217 728777



772876

- Cepillo de pared clásico 45 cm
- 45 cm classic brush
- Brosse de paroi classique 45 cm
- Spazzola parete classico 45 cm



CB PACK 12



3 605217 728760

■ material de limpieza ■ cleaning material ■ matériel de nettoyage ■ materiale di pulizia

786500

- Box material limpieza
- Cleaning material box
- Matériel de nettoyage box
- Box di materiale di pulizia



DIS PACK 1





778191	1	■ Dosificador ■ Dispenser ■ Diffuseur ■ Dosatore	24	3 605217 1781918
621201	2	■ Kit reparación liner. ■ Liner repair kit. ■ Kit réparation liner ■ Kit riparazione liner	36	3 605216 1212017
777580	3	■ Recogehojas fondo ■ Leaf rake ■ Épuisette de fond ■ Raccogliatore di fondo	20	3 605217 1775801
40068	4	■ Análisis cloro + pH + alcalinidad ■ Chlorine + pH + alkalinity analysis. ■ Analyse chlore + pH + alcalinité. ■ Análisi cloro + pH + alcalinità .	40	8 427370 1400681
783810	5	■ Recogehojas superficie ■ Leaf net ■ Épuisette de surface ■ Raccogliatore superficie	12	3 605217 1838100
772804	6	■ Recogehojas superficie PVC ■ PVC Leaf net ■ Épuisette de surface PVC ■ Raccogliatore superficie	20	3 605217 1728043
778201	7	■ Termómetros 16 cm ■ Thermometers 16 cm ■ Thermomètres 16 cm ■ Termometro 16 cm	33	3 605217 1782014
770340	8	■ Cepillo manual ■ Hand brush ■ Brosse à main ■ Spazzola manuale	21	3 605217 1703408
770326	9	■ Termómetros animal ■ Animal thermometers ■ Thermomètres animaux ■ Termometro animale	12	3 605217 1703262
772876	10	■ Cepillo de pared 45 cm ■ 45 cm hand wall brush ■ Brosse de paroi 45 cm ■ Spazzola manuale	12	3 605217 1728760
778192	11	■ Dosificador ■ Dispenser ■ Diffuseur ■ Dosatore	12	3 605217 1781925
770342	12	■ Mango telescópico. ■ Telescopic handle. ■ Manche télescopique. ■ Manico telescopico	16	3 605217 1703422

■ material de limpezia ■ cleaning material ■ matériel de nettoyage ■ materiale di pulizia

■ GAMA ECO ■ ECO RANGE ■ GAMME ECO ■ GAMMA ECO



90115

- Recogehojas de superficie
- Leaf net
- Épuisette de surface
- Raccogliatore di superficie



DIS PACK 24



8 427370 901157



90117

- Recogehojas de superficie + mango 122 cm.
- Leaf net + 122 cm handle.
- Épuisette de surface + manche 122 cm.
- Raccogliatore di superficie + Manico 122 cm.



CB PACK 24



8 427370 901171



90120

- Recogehojas de fondo
- Leaf rake
- Épuisette de fond
- Raccogliatore di fondo



DIS PACK 16



8 427370 901201



90184

- Recogehojas de superficie + mango 5 secciones 160 cm.
- Leaf net + 5 section pole 160 cm.
- Épuisette de surface + manche 5 sections 160 cm.
- Raccogliatore di superficie + manico sezionabile 160 cm.



CB PACK 12



8 412081 250915



90100

- Mango telescópico 3 x 120 cm.
- Telescopic handle 3 x 120 cm.
- Manche télescopique 3 x 120 cm.
- Manico telescopico 3 x 120 cm.



CB PACK 10



8 427370 901003



90105

- Limpiafondos 1/2 luna.
- Vacuum head.
- Balai demi-lune.
- Puliscifondo mezzaluna.



DIS PACK 12



8 427370 901058



90110

- Aspirador cepillo media luna.
- Jet vac with brush.
- Aspirateur brosse demi-lune.
- Aspiratore con spazzola a mezzaluna.



DIS PACK 8



8 427370 901102

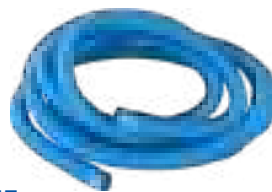

90135

- Manguera limpiafondos 9 m - Ø38 mm
- Vacuum hose 9 m - Ø38mm.
- Tuyau pour nettoyeur 9 m- Ø38 mm.
- Tubo puliscifondo 9 m - Ø38 mm.



BX PACK 1



8 427370 901355



90128

- Cepillo línea de agua
- Waterline brush
- Brosse ligne d'eau
- Spazzola per bordo acqua



DIS PACK 36



8 427370 901287



90127

- Cepillo 45 cm
- 45 cm brush
- Brosse 45 cm
- Spazzole 45 cm



DIS PACK 24



8 427370 901270



90125

- Cepillo 20 cm
- 20 cm brush
- Brosse 20 cm
- Spazzole 20 cm



CB PACK 16



8 427370 901256

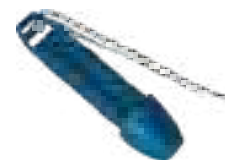

90130

- Termómetro universal.
- Universal thermometer.
- Thermomètre universel.
- Termometro universale.



DIS PACK 30



8 427370 901300



90132

- Termómetro animal.
- Animals thermometer.
- Thermomètre animaux.
- Termometro animale.



DIS PACK 60



8 427370 901324



90140

- Dosificador flotante tabletas 200 g.
- 200 g tablets floating dispenser.
- Doseur flottant pour galets 200 g.
- Dosatore galleggiante pastiglie 200 g.



DIS PACK 12



8 427370 901409



90141

- Dosificador flotante tabletas 20 g.
- 20 g tablets floating dispenser.
- Doseur flottant pour galets 20 g.
- Dosatore galleggiante pastiglie 20 g.



DIS PACK 40



8 427370 901416



90180

- Analizador de cloro/bromo + pH (Oto/Phenol).
- Test kit chlorine/bromine + pH (Oto/Phenol).
- Trousse d'analyse chlore/brome + pH (Oto/Phénol).
- Kit analisi cloro/bromo + pH (oto/Phenol).



DIS PACK 32



8 427370 901805



90181

- Recambio Oto/Phenol.
- Replacement Oto/Phenol.
- Recharge Oto/Phénol.
- Ricambio Oto/Phenol.



DIS PACK 60



8 427370 901812



90197N

- Box material limpezia
- Cleaning material box
- Matériel de nettoyage box
- Box di materiale di pulizia



DIS PACK 1



90127	1	■ Cepillo 45 cm ■ 45 cm brush ■ Brosse 45 cm ■ Spazzola 45 cm	12	8 427370 901270
770326	2	■ Termómetros animal ■ Animal thermometers ■ Thermomètres animaux ■ Termometro animale	12	3 605217 703262
90141	3	■ Dosificador pastillas 20 g ■ 20 g tablets dispenser ■ Doseur de pastilles 20 g ■ Dosatore pastiglie 20 g	12	8 427370 901416
40068	4	■ Análisis cloro + pH + alcalinidad ■ Chlorine + pH + alkalinity analysis. ■ Analyse chlore + pH + alcalinité. ■ Analisi cloro + pH + alcalinità .	16	8 427370 400681
90140	5	■ Dosificador tabletas 200 g ■ 200 g tablets dispenser ■ Doseur de galets 200 g ■ Dosatore pastiglie 200 g	12	8 427370 901409
40080	6	■ Kit reparación liner ■ Liner repair kit ■ Kit réparation liner ■ Kit riparazione line	24	8 427370 400803
90105	7	■ Limpiafondos 1/2 luna ■ Vacuum head ■ Balai demi-lune ■ Puliscifondo	6	8 427370 901058
40009	8	■ Unión 2 mangueras ■ 2 vacuum hoses union ■ Liaison pour tuyaux flottants ■ Raccordo unire tubi	12	8 427370 400094
90120	9	■ Recogehojas fondo ■ Leaf rake ■ Épuisette de fond ■ Raccogliitore di fondo	16	8 427370 901201
90130	10	■ Termómetro ■ Thermometers ■ Thermomètres ■ Termometro	15	8 427370 901300
90115	11	■ Recogehojas superficie ■ Leaf net ■ Épuisette de surface ■ Raccogliitore superficie	16	8 427370 901157
90128	12	■ Cepillo manual ■ Hand brush ■ Brosse à main ■ Spazzola manuale	18	8 427370 901287
90100	13	■ Mango telescópico ■ Telescopic handle ■ Manche télescopique ■ Manico telescopico	10	8 427370 901003

■ PROTECCIÓN INVIERNO ■ WINTER PROTECTION
 ■ HIVERNAGE ■ PROTEZIONE PER L'INVERNO



40580

- Flotador de invernaje.
- Winterising floating.
- Flotteur d'hivernage.
- Galleggiante inverno.



39 x 19,5 x 5 cm



BX PACK 10



8 427370 405808



PICI

- Cojín hinchable de protección para el invierno.
- Inflatable cushion for winter protection.
- Coussin gonflable de protection pour l'hiver.
- Cuscino gonfiabile per protezione invernale.



100 x 100 cm



BX PACK 8



8 412081 318394



40581

- Gizzmo - protección del skimmer.
- Gizzmo - skimmer protection.
- Gizzmo - protection du skimmer.
- Gizzmo - protezione per skimmer.



BX PACK 12



8 427370 405815



40582 | 40583

- Tapón de invernaje.
- Winterising plug.
- Bouchon d'hivernage.
- Tappo inverno.

40582

40583



1,5"

2"



BX PACK 6

BX PACK 6



8 427370 405822



8 427370 405839

■ material de limpezia ■ cleaning material ■ matériel de nettoyage ■ materiale di pulizia

■ MANGUERAS ■ VACUUM HOSES
■ TUYAUX FLOTTANTS ■ TUBI GALLEGGIANTI



40004

- Manguera limpiafondos 15 m - 2 terminales Ø38mm
- Vacuum hose 15 m with 2 cuffs Ø38 mm
- Tuyau pour nettoyeur de fond 15 m avec 2 embouts soudés Ø38mm
- Tubo pulisci fondo 15 m con 2 terminali da Ø38 mm



BX PACK 1



40003

- Manguera limpiafondos 12 m - 2 terminales Ø38 mm
- Vacuum hose 12 m with 2 cuffs Ø38 mm
- Tuyau pour nettoyeur de fond 12 m avec 2 embouts soudés Ø38 mm
- Tubo puliscifondo 12 m con 2 terminali da Ø38 mm



BX PACK 1



40002

- Manguera limpiafondos 10 m - 2 terminales Ø38 mm
- Vacuum hose 10 m with 2 cuffs Ø38 mm
- Tuyau pour nettoyeur de fond 10 m avec 2 embouts soudés Ø38mm
- Tubo pulisci fondo 10 m con 2 terminali da Ø38 mm



BX PACK 1



40001

- Manguera limpiafondos 8 m - 2 terminales Ø38 mm
- Vacuum hose 8 m with 2 cuffs Ø38 mm
- Tuyau pour nettoyeur de fond 8 m avec 2 embouts soudés Ø38mm
- Tubo puliscifondo 8 m con 2 terminali da Ø38 mm



BX PACK 1



AR210

- Manguera limpiafondos 6 m - 2 terminales Ø38 mm
- Vacuum hose 6 m with 2 cuffs Ø38 mm
- Tuyau pour nettoyeur de fond 6 m avec 2 embouts soudés Ø38 mm
- Tubo puliscifondo 6 m con 2 terminali da Ø38 mm



BX PACK 1



AR212

- Manguera limpiafondos 4 m - 2 terminales Ø38 mm
- Vacuum hose 4 m with 2 cuffs Ø38 mm
- Tuyau pour nettoyeur de fond 4 m avec 2 embouts soudés Ø38 mm
- Tubo puliscifondo 4 m con 2 terminali da Ø38 mm



BX PACK 1





770323

- Manguera limpiafondos 12 m - 2 terminales Ø32 mm
- Vacuum hose 12 m with 2 cuffs Ø32 mm
- Tuyau pour nettoyeur de fond 12 m avec 2 embouts soudés Ø32 mm
- Tubo puliscifondo 12 m con 2 terminali da Ø32 mm



BXL PACK 1



3 605217 703231



770322

- Manguera limpiafondos 7 m - 2 terminales Ø32 mm
- Vacuum hose 7 m with 2 cuffs Ø32 mm
- Tuyau pour nettoyeur de fond 7 m avec 2 embouts soudés Ø32 mm
- Tubo puliscifondo 7 m con 2 terminali da Ø32 mm



BXL PACK 1



3 605217 703224



90165

- Enrollador de mangueras flotantes hasta 15 m. (Manguera no incluida)
- Vacuum hoses roller maximum 15 m. (Vacuum hoses not included)
- Enrouleur de tuyaux flottants. Jusqu'à 15 m. (Tuyau non inclus)
- Avvolgitore per tubo galleggiante fino a 15 m. (Tubo non incluso)



CBX PACK 1



8 427370 901652



40012

- Terminal manguera flotante - Ø38 mm.
- Hose cuff - Ø38 mm.
- Embout tuyau flottant - Ø38 mm.
- Raccordo per tubo Ø38 mm.



BX PACK 12



8 427370 400124

chemicals



■ Producto químico

Información
Pasos para cuidar su piscina
PODS
Producto químico pH
Cloro
Bromo
Oxígeno activo
Multiacción
Antialgas
Floculante
Limpieza
Invernaje
Químico ECO
Tratamiento para el agua
Poolp'os
Kits piscina
Kits SPA
SPA Caps
Analizadores
Tiras analíticas

■ Chemicals

Information	186
Steps to take care of your swimming pool	188
PODS	190
pH chemicals	193
Chlore	194
Bromine	195
Active oxygen	195
Multi-action	196
Antialgae	198
Flocculant	199
Cleaning	200
Wintering	201
ECO chemicals	202
Water treatment	204
Poolp'os	206
Kits pour piscine	207
SPA kits	208
SPA Caps	209
Test kits	210
Analysis strips	211

■ Produits d'entretien

Information
Étapes à suivre pour prendre soin de votre piscine
PODS
pH chimique
Chlore
Brome
Oxygène actif
Multiaction
Anti-algues
Floculant
Nettoyage
Hivernage
Produits d'entretien ECO
Traitement de l'eau
Poolp'os
Kits pour piscine
Kits pour SPA
SPA Caps
Trousses d'analyse
Tiras analíticas

■ Prodotti chimici

Informazioni
Indicazioni per il trattamento della piscina
PODS
pH chimico
Cloro
Bromo
Ossigeno attivo
Multiazione
Antialghe
Flocculante
Pulizia
Svernamento
Prodotti chimici ECO
Trattamento delle acque
Poolp'os
Kit per piscine
Kit per SPA
SPA Caps
Kit tests
Analysis strips

■ VIVE TU PISCINA Y SUMÉRGETE EN LA DIVERSIÓN

Para ello, es necesario utilizar en cada momento los productos adecuados para el buen mantenimiento del agua de la piscina. Gre lo pone fácil con su nueva gama.

Hay 3 etapas a seguir para realizar un correcto mantenimiento de la piscina. Las diferenciamos en:

- 1 Start** Es la etapa en la que hacemos un **tratamiento inicial** necesario para poner a punto la piscina para la temporada de baño.
- 2 Play** Es la etapa de baño. Debemos llevar a cabo un **tratamiento de mantenimiento** que es crucial para poder disfrutar de la piscina con total seguridad.
- 3 Stop** Es la etapa en la que dejamos de bañarnos y debemos **mantener la piscina hasta la nueva temporada**. Esta etapa es igual de importante que las otras, para mantener la piscina en perfecto estado.

Además de estas 3 etapas, hay que tener en cuenta los diferentes tipos de productos. Los diferenciamos por su color de familia:

- Equilibrio** Productos destinados a equilibrar los parámetros del agua: pH y alcalinidad
- Desinfección** Productos que mantienen el agua libre de microbios
- Algicidas** Productos para prevenir de las algas
- Floculantes** Productos para mantener el agua limpia y transparente
- Multiacción** Productos todo en uno
- Limpieza** Productos para limpiar los elementos de la piscina
- Invernaje** Productos para mantener la piscina durante el invierno

■ LIVE YOUR POOL AND DIVE INTO FUN!

To this end, it is essential to use the right products in every step for a well-maintained pool water. Gre makes it easy for you with its new range.

There are 3 steps to follow in order to ensure the proper maintenance of your pool. We differentiate them in:

- 1 Start** It is the step where we carry out the necessary **initial treatment** to start-up your pool for the bathing season.
- 2 Play** It is the bathing season. We must carry out the crucial **maintenance treatment** that guarantees utmost security while enjoying your pool.
- 3 Stop** It is the step where we stop bathing and we must **maintain the pool until next season**. This stage is equally important as the others in order to keep the pool in a perfect state.

Apart from these 3 steps, we have to take into account the different types of products. We differentiate them by their family color:

- Balance** Products destined to balance water parameters: pH and alkalinity
- Disinfection** Products that keep water microbe-free
- Algaecides** Products that prevent algae growth
- Flocculants** Products to keep water clean and transparent
- Multiaction** All-in-one products
- Cleaning** Products to clean the pool elements
- Wintering** Products to maintain the pool during the winter.

■ Logo en grande, tapas azules y gran mancha azul para facilitar el reconocimiento de marca

■ A big logo, blue lids and a large blue band to facilitate brand recognition

■ Un grand logo, des couvercles bleus et un grand aplat bleu pour faciliter l'identification de la marque

■ Logo di grandi dimensioni, coperchi azzurri e grande area azzurra per agevolare il riconoscimento del marchio

■ Nombre de producto

■ Product name

■ Nom du produit

■ Nome del prodotto

■ Descripción

■ Description

■ Description

■ Descrizione

■ Tipo de piscina

■ Pool type

■ Type de piscine

■ Tipo di piscina

■ Familia de producto

■ Product family

■ Famille de produit

■ Tipologia del prodotto

■ Etapa de uso

■ Usage stage

■ Étapes d'utilisation

■ Fase di utilizzo

■ Formato

■ Format

■ Format

■ Formato

■ Dosificación

■ Dosage

■ Dosage

■ Dosaggio

■ PLONGEZ DANS L'UNIVERS DIVERTISSANT DE LA PISCINE

Afin de maintenir la qualité de l'eau de votre piscine, il est nécessaire de toujours utiliser les produits adéquats.

Il y a **3** étapes à suivre pour réaliser un entretien correct de votre piscine. Il s'agit de :

1 Start

C'est l'étape durant laquelle nous réalisons un **traitement initial** pour procéder à la mise en route de la piscine en début de saison.

2 Play

Durant la saison de baignade, nous devons effectuer un **traitement d'entretien** qui est essentiel pour pouvoir profiter pleinement de la piscine et en toute sécurité.

3 Stop

La troisième étape marque la fin de la saison de baignade où l'on doit **entretenir la piscine jusqu'à la prochaine saison**. Cette étape est tout aussi importante que les autres afin de maintenir votre piscine en parfait état.

En plus de ces 3 étapes, il faut tenir compte des différents types de produits. Nous les différencions par leurs couleurs de famille :

Équilibre Produits permettant d'équilibrer les paramètres de l'eau : pH et alcalinité

Désinfection Produits pour conserver une eau sans impuretés

Algicides Produits pour prévenir l'apparition d'algues

Floculants Produits pour maintenir une eau propre et transparente

Multiaction Produits tout-en-un

Nettoyage Produits pour nettoyer les différents éléments de la piscine

Hivernage Produits pour entretenir la piscine durant la période d'hivernage

■ VIVI LA TUA PISCINA E IMMERGITI NEL DIVERTIMENTO

A tal proposito è necessario utilizzare sempre prodotti idonei al corretto trattamento dell'acqua della piscina. Gre agevola questa operazione con la sua nuova gamma di prodotti.

Per effettuare una corretta manutenzione della piscina occorre seguire **3** fasi che vengono descritte a continuazione:

1 Start

Vi è una fase in cui viene eseguito un **trattamento iniziale** con la funzione di preparare la piscina per la stagione balneare.

2 Play

Vi è quindi la fase di utilizzo della piscina. Occorre effettuare un **trattamento di mantenimento** che è essenziale per poter utilizzare la piscina nella massima sicurezza.

3 Stop

Vi è quindi la fase in cui si smette di utilizzare la piscina ed occorre quindi effettuare la **manutenzione per preservarla fino alla stagione successiva**. Questa fase ha la medesima importanza delle altre due per mantenere la piscina in perfetto stato.

Oltre alle tre fasi occorre considerare le differenti tipologie di prodotto. Li differenziamo per tipologia:

Equilibrio Prodotti destinati a equilibrare i parametri dell'acqua: pH e alcalinità

Disinfezione Prodotti che mantengono l'acqua priva di microbi

Algicidi Prodotti per la prevenzione delle alghe

Floculanti Prodotti per mantenere l'acqua limpida e trasparente

Multiazione Prodotti tutto in uno

Pulizia Prodotti per la pulizia degli elementi della piscina

Svernamento Prodotti per la pulizia della piscina nella stagione invernale



■ producto químico ■ chemicals ■ produits d'entretien ■ prodotti chimici

- PASOS PARA CUIDAR DE SU PISCINA
- STEPS TO TAKE CARE OF YOUR SWIMMING POOL
- ÉTAPES À SUIVRE POUR PRENDRE SOIN DE VOTRE PISCINE
- INDICAZIONI PER IL TRATTAMENTO DELLA PISCINA

1 Start

- Tratamiento inicial para la puesta a punto
- Initial treatment for the start-up

- Traitement initial pour la mise en route de la piscine
- Trattamento iniziale per la messa a punto

- 1- Limpieza del exterior de la piscina ■ 1- Nettoyage de l'extérieur de la piscine
- 1- Cleaning the pool surroundings ■ 1- Pulizia dell'esterno della piscina

LIMPIEZA · CLEANING · NETTOYAGE · PULIZIA

Waterline CLEANER	<ul style="list-style-type: none"> ■ Eliminar la suciedad de la línea de flotación ■ Remove dirt from the waterline ■ Éliminer la saleté de la ligne d'eau ■ Eliminare lo sporco dalla linea di galleggiamento
AntiCALC	<ul style="list-style-type: none"> ■ Prevenir la formación de cal ■ Prevent limescale ■ Empêcher la formation de calcaire ■ Prevenire la formazione del calcare

- 2- Limpieza del agua
- 2- Water cleaning

- 2- Nettoyage de l'eau
- 2- Pulizia dell'acqua

EQUILIBRIO · BALANCE · ÉQUILIBRE · EQUILIBRIO

pH MINUS, pH PLUS, Tac PLUS	<ul style="list-style-type: none"> ■ Equilibrar los parámetros del agua ■ Balance water parameters ■ Équilibrer les paramètres de l'eau ■ Equilibrare i parametri dell'acqua
-----------------------------------	--

DESINFECCIÓN · DISINFECTION · DÉSINFECTION · DISINFEZIONE

ClorCHOC, BromCHOC	<ul style="list-style-type: none"> ■ Tratamiento de choque para eliminar todos los gérmenes y contaminantes del agua ■ Shock treatment to remove all germs and contaminants from the water ■ Traitement de choc pour éliminer tous les germes et polluants de l'eau ■ Trattamento choc per eliminare tutti i germi e le sostanze inquinanti dall'acqua
-----------------------	--

FLOCULANTE · FLOCCULANT · FLOCULANT · FLOCCULANTE

Floculant	<ul style="list-style-type: none"> ■ Clarificar el agua y mejorar el rendimiento de la filtración ■ Clarify the water and improve the filter's performance ■ Clarifier l'eau et améliorer la performance du filtre ■ Rendere limpida l'acqua e migliorare la resa della filtrazione
-----------	---

2 Play

- Tratamiento de mantenimiento
- Traitement d'entretien
- Maintenance treatment
- Trattamento di mantenimento

EQUILIBRIO · BALANCE · ÉQUILIBRE · EQUILIBRIO

pH MINUS,
pH PLUS,
Tac PLUS

- Equilibrar los parámetros del agua
- Balance water parameters
- Équilibrer les paramètres de l'eau
- Equilibrare i parametri dell'acqua

MANTENIMIENTO · MAINTENANCE · ENTRETIEN · MANTENIMENTO

ClorLENT,
BromLENT

- Desinfectar permanentemente
- Continuous disinfection
- Désinfecter en continu
- Disinfezione permanente

ALGICIDA · ALGAECIDE · ALGICIDE · ANTIALGHE

AntiALG,
AntiALG XTRA

- Prevenir la aparición de algas y eliminar las algas existentes
- Prevent algae growth and remove the existing ones
- Prévenir l'apparition d'algues et éliminer les algues existantes
- Prevenire la comparsa di alghe ed eliminare le alghe esistenti

FLOCULANTE · FLOCCULANT · FLOCULANT · FLOCCULANTE

Floculant

- Clarificar el agua y mejorar el rendimiento de la filtración
- Clarify the water and improve the filter's performance
- Clarifier l'eau et améliorer la performance du filtre
- Rendere limpida l'acqua e migliorare la resa della filtrazione

MULTIACCIÓN · MULTIACTION · MULTIACTION · MULTIAZIONE

Compleat 5,
Total 5,
Total 10

- Cloro, antialgas y floculantes en una sola aplicación
- Chlorine, anti-algae and flocculant in a single application
- Chlore, anti-algues et flocculant en une seule application
- Cloro, antialghe e flocculanti in un'unica applicazione

3 Stop

- Tratamiento de invierno
- Traitement d'hivernage
- Wintering
- Trattamento per l'inverno

EQUILIBRIO · BALANCE · ÉQUILIBRE · EQUILIBRIO

pH MINUS,
pH PLUS

- Equilibrar los parámetros del agua
- Balance water parameters
- Équilibrer les paramètres de l'eau
- Equilibrare i parametri dell'acqua

DESINFECCIÓN · DISINFECTION · DÉSINFECTION · DISINFEZIONE

ClorCHOC,
BromCHOC

- Eliminar todos los gérmenes y contaminantes del agua
- Remove all germs and contaminants from the water
- Éliminer tous les germes et polluants de l'eau
- Eliminare tutti i germi e le sostanze inquinanti dall'acqua

INVERNAJE · WINTERING · HIVERNAGE · SVERNAMENTO

Winter,
WinterFLOAT

- Tratamiento completo durante el invierno
- Complete treatment during winter
- Traitement complet en période d'hivernage
- Trattamento invernale completo



- MINORADOR DE pH ■ pH REDUCE
- BAISSÉ LE pH ■ RIDUTTORE pH

pH MINUS

- MONODOSIS ■ SINGLE-DOSE ■ ECODOSES ■ MONODOSI

Ref. PPHME 750 g DIS 5 8 4 12081 303055

Ref. PPHM 750 g DIS 5 8 4 12081 302966



- INCREMENTADOR DE pH ■ pH INCREASE
- AUGMENTE LE pH ■ INCREMENTATORE pH

pH PLUS

- MONODOSIS ■ SINGLE-DOSE ■ ECODOSES ■ MONODOSI

Ref. PPHPE 650 g DIS 5 8 4 12081 303048

Ref. PPHP 650 g DIS 5 8 4 12081 302959



- CLORO CHOQUE ■ SHOCK CHLORINE
- CHLORE CHOC ■ CLORO SHOCK

CLORCHOC

- MONODOSIS ■ SINGLE-DOSE ■ ECODOSES ■ MONODOSI

Ref. PCLSCH 300 g DIS 5 8 4 12081 303062

Ref. PCLSCH 300 g DIS 5 8 4 12081 302973



- COMPLET 4 ACCIONES ■ COMPLET 4 ACTIONS
- COMPLET 4 AZIONI

CHLORE 4 ACTIONS

- MONODOSIS ■ SINGLE-DOSE ■ ECODOSES ■ MONODOSI

Ref. PCLMULEL 5x250 g DIS 6 8 4 12081 320120

Ref. PCLMULL 5x250 g DIS 6 8 4 12081 320137



- Clear Dose: químicos para piscinas en monodosis
- Clear Dose: swimming pool chemicals in single doses
- Clear Dose: produits chimiques pour piscine en doses
- Clear Dose: prodotti chimici per piscine monodose



- ANTIALGAS ■ ANTI ALGAE
- ANTI-ALGUES ■ ANTIALGHE

ANTI - ALGUES

- MONODOSIS ■ SINGLE-DOSE ■ ECODOSES ■ MONODOSI

Ref. PALGE 8x20 g DIS 6 8 4 12081 303086

Ref. PALG 8x20 g DIS 6 8 4 12081 302997



- FLOCULANTE ■ FLOCCULANT
- FLOCULANT ■ FLOCCULANTE

FLOCCULANT

- MONODOSIS ■ SINGLE-DOSE ■ ECODOSES ■ MONODOSI

Ref. PNATCLE 4x30 g DIS 8 8 4 12081 303093

Ref. PNATCL 4x30 g DIS 8 8 4 12081 303000



- Antialgas + Floculante + Antical + Agua libre de aceites y espuma
- Antialgae + Flocculant + Anti lime + Water free of oils and foam
- Anti-algues + Flocculant + Anti-calcaire + Eau sans huile ni mousse
- Antialghe + Flocculante + Anticalcaire + Acqua priva di oli e schiuma

MULTIPROTECT

- MONODOSIS ■ SINGLE-DOSE ■ ECODOSES ■ MONODOSI

Ref. PCPMPE 8x35 g DIS 5 8 412081 303108

Ref. PCPMP 8x35 g DIS 5 8 412081 303017

- Filtro de cartucho ■ Cartridge filter ■ Epurateur à cartouche ■ Filtri a cartuccia

Ref. PCPMPCE 8x35 g DIS 5 8 412081 303116

Ref. PCPMPC 8x35 g DIS 5 8 412081 303024



- INVERNADOR ■ WINTERISER
- HIVERNAGE ■ TRATTAMENTO PER L'INVERNO

- MONODOSIS ■ SINGLE-DOSE ■ ECODOSES ■ MONODOSI

Ref. PWINTCE 350 g DIS 5 8 4 12081 303123

Ref. PWINTC 350 g DIS 5 8 4 12081 303031



■ producto químico ■ chemicals ■ produits d'entretien ■ prodotti chimici

■ **Cálculo de volumen de agua**

Para un correcto suministro del producto químico, es importante calcular el volumen de agua de la piscina.

■ **Calcul du volume d'eau**

Pour un bon dosage du produit chimique, il est nécessaire de calculer le volume d'eau de la piscine.

■ **Calculate the pool water volume**

It is important to calculate the pool water volume to do a correct chemical treatment.

■ **Calcolo del volume d'acqua**

Per un corretto dosaggio del prodotto chimico è importante calcolare il volume d'acqua di una piscina.



$V = L \times l \times P$

$V = D \times D \times P \times 0,785$

$V = L \times l \times P \times 0,785$

$V = L \times l \times P \times 0,85$

V	Volumen en m ³	Volume en m ³	Volume en m ³	Volume in m ³
L	Longitud en m	Length in m	Longueur en m	Lunghezza in m
l	Anchura en m	Width in m	Largeur en m	Larghezza in m
D	Diámetro en m	Diameter in m	Diamètre en m	Diametro in m
P	Profundidad en m	Depth in m	Profondeur en m	Profondità in m

Ejemplo Example Exemple Esempio

$1,5 \text{ m} \times 8 \times 4 \times 0,785 = 37,68 \text{ m}^3$

■ **Leyenda** ■ **Legend** ■ **Légende** ■ **Legenda**

	500 g				1 L
	1 Kg		10 Kg		
	1 Kg /1,5 Kg		1 L		1 kg
	3 kg		3 L		1 L / 0,5 L
	5 Kg		5 L		1/2 BOX PALET
	5 Kg		10/20 L		



- Cómo mantener el agua de la piscina durante el verano
- How to maintain pool water during the summer
- Comment entretenir l'eau de la piscine en été
- Come mantenere l'acqua della piscina in estate

Equilibrio | Balance | Équilibre | Equilibrio

1 Start 2 Play 3 Stop

■ El pH indica la acidez o la basicidad del agua. En una piscina debe mantenerse ajustado entre los valores 7.2 y 7.6, ya que además de conservar las instalaciones en óptimas condiciones, es el ideal para la piel y los ojos de los bañistas.

■ pH shows if water is acid or basic. Pool water pH must be between 7.2 and 7.6, because it helps to conserve the equipment in good conditions and it is ideal for swimmer eyes and skin.

■ Le pH indique l'acidité ou la basicité de l'eau. L'eau de la piscine doit se maintenir entre les taux 7.2 et 7.6, car cela aide non seulement à mieux conserver les installations, mais c'est également le taux idéal pour protéger la peau et les yeux des baigneurs.

■ Il pH indica la acidità e la basicità dell'acqua. In una piscina il valore di riferimento deve essere sempre tra 7.2 e 7.6, dal momento che, oltre a favorire il trattamento chimico che viene effettuato, è il valore ideale affinché la pelle e gli occhi dei bagnanti non si irritino.



■ MINORADOR DE pH ■ pH REDUCE ■ BAISSÉ LE pH ■ RIDUTTORE pH

pH MINUS

■ GRANULADO ■ GRANULES ■ GRANULÉS ■ GRANULATO

 Ref. 76019 1,5 Kg Pack 20 8 427370 760198

 Ref. 76002 5 Kg Pack 4 8 427370 760020

 Ref. 76095 20 l Pack 1 8 412081 313948

- Minorador de pH: para bajar y estabilizar el pH
- pH reduce: to lower and stabilize pH
- Baisse le pH: pour baisser et stabiliser le pH
- Per abbassare e stabilizzare il pH



■ INCREMENTADOR DE pH ■ pH INCREASE ■ AUGMENTE LE pH ■ INCREMENTATORE pH

pH PLUS

■ GRANULADO ■ GRANULES ■ GRANULÉS ■ GRANULATO

 Ref. 76018 1 Kg Pack 20 8 427370 760181

 Ref. 76001 5 Kg Pack 4 8 427370 760013

- Incrementador de pH: para aumentar y estabilizar el pH
- pH increase: to increase and stabilize pH
- Augmente le pH: pour augmenter et stabiliser le pH
- Per aumentare e stabilizzare il pH

Equilibrio | Balance | Équilibre | Equilibrio

1 Start 2 Play 3 Stop



TAC PLUS

■ GRANULADO ■ GRANULES ■ GRANULÉS ■ GRANULATO

 Ref. 76081 5 Kg Pack 4 8 427370 760815

- Incrementador de alcalinidad
- Alkalinity increase
- Augmente l'alcalinité
- Elevatore di alcalinità

7.2

7.6

pH OK

use pH+

use pH-

Desinfección | Disinfection | Désinfection | Disinfezione

1 Start 2 Play 3 Stop

CLORCHOC

■ El Cloro Choque permite destruir rápida y eficazmente todos los organismos, hongos y bacterias. Conviene realizar una cloración de choque: Al inicio de la temporada de baño / Después de condiciones climáticas extremas / En caso de uso intensivo de la piscina.

■ It eliminates quickly all the organisms and bacteria. It is necessary to do a Shock chlorination: At the beginning of the swim season / After bad weather conditions / High use level.

■ Le Chlore Choc permet de détruire rapidement et efficacement tous les organismes, champignons et bactéries. Il convient d'effectuer une chloration choc: Au début de la saison de baignade / Après des conditions climatiques extrêmes / En cas d'usage intensif de la piscine.

■ Permette di eliminare rapidamente ed efficacemente tutti gli organismi, funghi e batteri. E' utile usare questo tipo di prodotto: All'inizio della stagione / Dopo condizioni climatiche estreme / In caso di un uso intensivo della piscina.

■ PASTILLAS ■ TABLETS ■ PASTILLES ■ PASTIGLIE 30 g

 Ref. 76074L 1 Kg Pack 18 8 4 12081 320519

 76100L 8412081320526

 Ref. 76075L 3 Kg Pack 4 8 4 12081 320540

 76059L 8412081320557

 Ref. 76076L 5 Kg Pack 4 8 4 12081 320618

 76099L 8412081320625

■ GRANULADO ■ GRANULES ■ GRANULÉS ■ GRANULATO

 Ref. 76021 1 Kg Pack 18 8 4 27370 760211

 76066 8412081315317

 Ref. 76062 1 Kg Pack 210 8 4 27370 760624

 76079 8412081315300

 Ref. 76069 3 Kg Pack 4 8 4 27370 760693

 76096 8412081315324

 Ref. 76004 5 Kg pack 4 8 4 27370 760044

 76078 8412081315294

 Ref. 76064 5 Kg Pack 60 8 4 27370 760648

 76097 8412081315331

Mantenimiento | Maintenance | Entretien | Manutenzione

1 Start 2 Play 3 Stop



CLORLENT

■ Para conseguir una higienización preventiva y continua del agua, es necesario mantener una tasa de cloración libre. Por ello, conviene efectuar una cloración permanente o "cloración lenta".

■ To have a preventive and continue sanitizing, it is necessary to keep a free chlorination value. For this reason, people must do a permanent chlorination or a "slow chlorination".

■ Pour avoir une hygiénisation préventive et continue, il est nécessaire de maintenir un taux de chloration libre. Pour cette raison, il faut effectuer une chloration permanente ou «chloration lente».

■ Per ottenere una igienizzazione preventiva e continua dell'acqua, è necessario mantenere un valore di cloro "libero". Per questo è bene effettuare una clorazione continua o una "clorazione lenta".

■ TABLETAS ■ TABLETS ■ GALETS ■ PASTIGLIE 250 g

 Ref. 76022L 1 Kg Pack 18 8 4 12081 320762

 Ref. 76005L 5 Kg Pack 4 8 4 12081 320809

■ GRANULADO ■ GRANULES ■ GRANULÉS ■ GRANULATO

 Ref. 76023 1 Kg Pack 18 8 4 27370 760235

CHLORINE STABILISER

■ Prolonga y optimiza la acción desinfectante del cloro.



■ Prolongs and optimises the disinfectant action of chlorine.

■ Prolonge et optimise l'action désinfectante du chlore.

■ Prolunga e ottimizza l'azione disinfettante del cloro

■ GRANULADO ■ GRANULES ■ GRANULÉS ■ GRANULATO

 Ref. 76112  1 Kg Pack 12 8 4 12081 290317

 Ref. 76113  4,5 Kg Pack 4 8 4 12081 290324



■ BROMO ■ BROMINE ■ BROME ■ BROMO

- Diferencias respecto al cloro: menos olor, no daña la piel ni el cabello. Más eficacia en las aguas calientes y/o calcáreas.
- Differences compared to chlorine: less smell, does not dry out skin and hair. More efficient in hot and/or calcareous water.
- Différences par rapport au chlore: moins d'odeur, ne dessèche pas la peau ni les cheveux. Plus efficace dans les eaux chaudes et/ou calcaires.
- Differenze rispetto al cloro: meno odore, non danneggia la pelle né i capelli. Più effi cace con l'acqua molto calda e/o calcarea.

BROM'LENT

■ PASTILLAS ■ TABLETS ■ PASTILLES ■ PASTIGLIE 20g

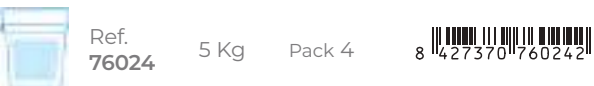

BROM CHOC

■ GRANULADO ■ GRANULES ■ GRANULÉS ■ GRANULATO

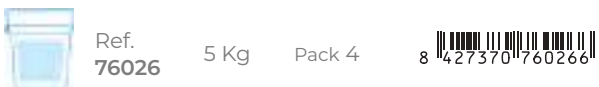

Referencia no disponible para España

BROM MULTICTIONS

■ PASTILLAS ■ TABLETS ■ PASTILLES ■ PASTIGLIE 20g



- Bromo multi-Acciones
- Bromine multi-Actions
- Brome multi-Actions
- Bromo multi funzioni



■ OXÍGENO ACTIVO ■ ACTIVE OXYGEN ■ OXYGÈNE ACTIF ■ OSSIGENO ATTIVO

- Ofrece muchas ventajas, ya que proporciona una desinfección muy eficaz y a diferencia del cloro, no provoca irritaciones oculares ni desprende olores desagradables. Producto que necesita de un dosificador.
- This product offers a lot of advantages. It disinfects pool water and contrary to chlorine, it does not cause eye irritation neither and bad smells. This product needs a dispenser.
- Ce produit offre de nombreux avantages par rapport au chlore, car il ne provoque aucune irritation oculaire, ôte les mauvaises odeurs et désinfecte très efficacement. Un doseur est nécessaire pour utiliser ce produit.
- Offre molti vantaggi, dal momento che sviluppa una igienizzazione molto efficace e, a differenza del cloro, non irrita gli occhi e non ha un odore sgradevole. E' un prodotto che necessita del dosatore.

ACTI OXY

■ LÍQUIDO ■ LIQUID ■ LIQUIDE ■ LIQUIDO



■ PASTILLAS ■ TABLETS ■ PASTILLES ■ PASTIGLIE 20g

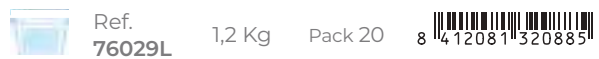

Uniquement pour la france

STICK HIPOCAL

- Disolución lenta para desinfección permanente de la piscina.
- Prolongs and optimises the disinfectant action of chlorine.
- Dissolution lente pour une désinfection permanente de la piscine.
- A lenta dissoluzione per una disinfezione permanente della piscina.

■ GRANULADO ■ GRANULES ■ GRANULÉS ■ GRANULATO



- Hipoclorito cálcico en sticks de 300 g
- Calcium hypochlorite in 300 g sticks
- Hypochlorite de calcium en bâtonnets de 300 g
- Ipoclorito di calcio in bastoncini da 300 g

Uniquement pour la france

Multiacción | Multi-action | Multiaction | Multiazione

1 Start 2 Play 3 Stop



■ Se trata de un producto revolucionario, ya que gracias a su fórmula innovadora permite en una sola aplicación, eliminar las bacterias, virus y microorganismos en general, evitar el desarrollo de algas, al mismo tiempo que mantiene transparente y cristalina el agua.

■ Revolution product: Thanks to its new formula, allows in a single application eliminate bacteria, virus and micro organisms, avoid algae and have clear and crystalline water.

■ Il s'agit d'un produit révolutionnaire. Grâce à sa formule innovatrice, il permet avec une seule application, d'éliminer les bactéries, virus et micro-organismes en général, d'éviter l'apparition d'algues et de conserver une eau transparente et cristalline.

■ Si tratta di un prodotto rivoluzionario proprio perché, grazie alla sua formula innovatrice, permette, in una sola applicazione, di eliminare i batteri, virus e tutti i microrganismi evitando il proliferare di alghe, mantenendo allo stesso tempo l'acqua trasparente e cristallina.

- Cloro + Antialgas + Estabilizante + Flocculante
- Chlorine + Antialgae + Stabiliser + Flocculant
- Chlore + Anti-algues + Stabilisant + Flocculant
- Cloro + Antialghe + Stabilizzante + Flocculante

COMPLET 4 ACTIONS

■ PASTILLAS ■ TABLETS ■ PASTILLES ■ PASTIGLIE 250g

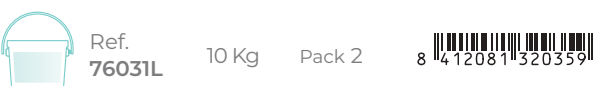
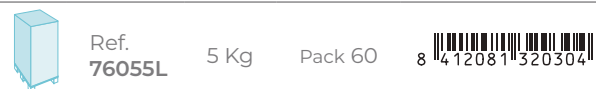

■ PASTILLAS ■ TABLETS ■ PASTILLES ■ PASTIGLIE 20g



■ GRANULADO ■ GRANULES ■ GRANULÉS ■ GRANULATO



COMPLET 4 ACTIONS- SPECIAL LINER

■ PASTILLAS ■ TABLETS ■ PASTILLES ■ PASTIGLIE 250g

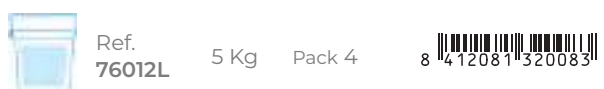

- Sin sulfato de cobre
- Without copper sulphate.
- Sans sulfate de cuivre
- Senza solfato di rame



- Cloro + Antialgas + Estabilizante + Floculante + Antical
- Chlorine + Antialgae + Stabiliser + Flocculant + Anti lime
- Chlore + Anti-algues + Stabilisant + Flocculant + Anti-calcaire
- Cloro + Antialghe + Stabilizzante + Floculante + Anticalcare

TOTAL 5 ACTIONS

■ PASTILLAS ■ TABLETS ■ PASTILLES ■ PASTIGLIE 250g



Ref. **76082L** 1 Kg pack 18 8 4 1208 1 320403



Ref. **76068L** 3 Kg pack 4 8 4 1208 1 320427



Ref. **76036L** 5 Kg pack 4 8 4 1208 1 320458



Ref. **76037L** 10 Kg pack 2 8 4 1208 1 320472



- Desinfectante + Bactericida + Floculante + Coagulante + Algicida + Algistático + Regulador de pH + Estabilizante de cloro + Anticalcáreo + Viricida + Fungicida
- Disinfectant+ Germicide + Flocculent + Coagulant + Algicide + Algistatic + pH regulator + Chlorine stabilizer + Anti-Limescale Agent + Virucide+ Fungicide
- Désinfectant + Bactéricide + Flocculant + Coagulant + Algicide + Algistatique + Régulateur de pH + Stabilisant de chlore + Anticalcaire + Virucide + Fongicide
- Disinfettante + Battericida + Floculante + Coagulante + Alghicida + Alghistatico + Regolatore di pH + Stabilizzatore del cloro + Anticalcare + Virucida + Funghicida

TOTAL 10 ACTIONS

■ PASTILLAS ■ TABLETS ■ PASTILLES ■ PASTIGLIE 250g



Ref. **76065L** 1 Kg pack 18 8 4 1208 1 320380



Ref. **76038L** 5 Kg pack 4 8 4 1208 1 320090

- Cloro + Floculante + Coagulante + Anti alghe + Alghestatico + Regolatore di pH + Stabilizzatore + Anticalcare

TOTAL 8 ACTIONS

PASTIGLIE 250g



Ref. **76060L** 1 Kg pack 18 8 4 1208 1 320397



Ref. **76061L** 5 Kg pack 4 8 4 1208 1 320106

Solo per l'Italia

Multiacción | Multi-action | Multiaction | Multiazione

1 Start 2 Play 3 Stop



ANTIALG XTRA

■ LÍQUIDO ■ LIQUID ■ LIQUIDE ■ LIQUIDO



Ref. 76041 1 L Pack 12 8 427370 760419



Ref. 76042 5 L Pack 4 8 427370 760426

- 3 acciones. Extra: para eliminar todas las algas.
- 3 actions. Extra: to eliminate the algae.
- 3 actions. Extra: pour éliminer la totalité des algues.
- 3 azioni. Extra. Per eliminare tutti i tipi di alghe.

ANTIALG

■ LÍQUIDO ■ LIQUID ■ LIQUIDE ■ LIQUIDO



Ref. 76009 1 L Pack 12 8 427370 760099



Ref. 76071 3 L Pack 6 8 427370 760716



Ref. 76008 5 L Pack 4 8 427370 760082



Ref. 76056 5 L Pack 48 8 427370 760563

- Para prevenir la aparición de algas.
- To prevent the appearance of algae.
- Pour prévenir l'apparition d'algues.
- Per prevenire la comparsa delle alghe.

■ Las algas son organismos vegetales unicelulares que pueden desarrollarse y multiplicarse rápidamente en el agua, sobre todo cuando su temperatura es templada.

■ Algae are vegetal unicellular organisms that can quickly develop and multiply themselves in the water, specially when the temperature of the water is warm.

■ Les algues sont des organismes végétaux unicellulaires qui peuvent apparaître et se multiplier très rapidement dans l'eau, surtout quand la température de l'eau est tempérée.

■ Le alghe sono organismi vegetali unicellulari che possono svilupparsi e moltiplicarsi soprattutto quando la temperatura dell'acqua è abbastanza calda.



ANTIALG COMPACT XTRA

■ LÍQUIDO ■ LIQUID ■ LIQUIDE ■ LIQUIDO



Ref. 76013 1 L Pack 12 8 427370 760136

ANTIALG COMPACT

■ LÍQUIDO ■ LIQUID ■ LIQUIDE ■ LIQUIDO



Ref. 76015 1 L Pack 12 8 427370 760150

1 Start 2 Play 3 Stop

■ La floculación permite obtener un agua cristalina. Existen dos tipos de floculación: la que se realiza dentro del filtro y la floculación dentro del vaso. La primera permite aumentar la fineza de filtración y eliminar de esta manera las partículas más finas. Ésta se efectúa gracias a los cartuchos floculantes (incompatibles con filtros de cartucho) colocados en el cesto del skimmer. La segunda permite agrupar entre ellas las impurezas que no pueden ser filtradas individualmente y que son el origen de un agua turbia. Esta operación se efectúa con el floculante líquido.

■ Flocculation allows to obtain a crystalline water. There are two kind of flocculation: inside the filter and in the pool. With the first one we increase the fineness of filtration in order to eliminate smaller particles. For this process we introduce flocculants cartridges (incompatible with cartridge filters) in the skimmer basket. The second one helps us to group all the impurities that are the beginning of brown water thanks to liquid flocculant.



■ CARTUCHOS ■ CARTRIDGES ■ CARTOUCHES ■ CARTUCCIA 125g

Ref. 76044 1 Kg Pack 14 8 427370 760440

- Para mejorar la calidad de filtración (filtros de arena únicamente). Producto de mantenimiento.
- To increase filtration quality (sand filters only). Product Maintenance.
- Pour améliorer la qualité de filtration (filtres à sable uniquement). Produit de maintenance.
- Per migliorare la qualità della filtrazione (solo per filtri a sabbia). Prodotto di mantenimento.



■ MONODOSIS ■ PODS ■ MONODOSE ■ MONODOSI

Ref. UFG20 28g DIS 24 8 412081 314020

- Ultraflock: Gel floculante
- Ultraflock: Flocculant Gel
- Ultraflock: Floculant en gel monodose
- Ultraflock: flocculante gel.

1 Start 2 Play 3 Stop

■ La floculation permet d'obtenir une eau cristalline. Il y a deux types de floculation: celle qui se fait dans le filtre et la floculation dans le bassin. La première permet d'augmenter la finesse de filtration et d'éliminer de cette façon les particules les plus fines. Elle s'effectue grâce aux cartouches floculantes (incompatibles avec les filtres à cartouche) qui sont placées dans le panier du skimmer. La deuxième permet de regrouper entre elles les impuretés qui ne peuvent pas être filtrées et qui sont à l'origine des eaux troubles. Cette opération se fait avec le floculant liquide.

■ La flocculazione permette di ottenere un'acqua cristallina. Esistono due tipi di flocculazione: quella che si realizza all'interno del filtro e quella diluendo il prodotto in un contenitore. La prima permette di migliorare la filtrazione ed eliminare le particelle più fini e si effettua grazie alle cartucce flocculanti (incompatibili con i filtri a cartuccia) poste dentro il cesto dello skimmer. La seconda permette di raggruppare tra loro le impurità che non possono essere filtrate individualmente e che sono la causa dell'acqua torbida. Questo procedimento si effettua con il floculante liquido.



FLOCCULANT

■ LÍQUIDO ■ LIQUID ■ LIQUIDE ■ LIQUIDO

Ref. 76011 1 L Pack 12 8 427370 760112

Ref. 76104 1 L Pack 12 8 412081 321356

*NATURAL CLARIFIER

Ref. 76073 3 L Pack 6 8 427370 760730

Ref. 76010 5 L Pack 4 8 427370 760105

- Para clarificar el agua y eliminar las materias en suspensión. Recupera el agua turbia.
- To clarify water and eliminate substances in suspension. Retrieve the cloudy water.
- Pour clarifier l'eau et éliminer les matières en suspension. Récupère l'eau trouble.
- Rende acqua cristallina ed elimina le particelle in superficie. Recupera l'acqua torbida.

Limpieza | Cleaning | Nettoyage | Pulizia

1 Start 2 Play 3 Stop



- DESINCRUSTANTE DE SUPERFICIE
- SURFACE DESCALER
- DÉTARTRANT DE SURFACE
- PULITORE SUPERFICI D'ACQUA

DETRATANT SURFACE

■ LÍQUIDO ■ LIQUID ■ LIQUIDE ■ LIQUIDO



Ref. 76046 1 L Pack 12 8 427370 760464

- Para eliminar incrustaciones de cal.
- To eliminate lime scales.
- Pour éliminer les incrustations calcaires.
- Per evitare la incrostazione del calcare.

- LIMPIADOR DE BORDES
- WATERLINE CLEANER
- NETTOYANT LIGNE D'EAU
- PULITORE SUPERFICI D'ACQUA

NETTOYANT LIGNE D'EAU

■ LÍQUIDO ■ LIQUID ■ LIQUIDE ■ LIQUIDO



Ref. 76047 1 L Pack 12 8 427370 760471

- Para eliminar la suciedad de la línea de flotación.
- To eliminate the dirt on the waterline.
- Pour éliminer la saleté sur la ligne d'eau.
- Per eliminare particelle in superficie.



- ANTICALCÁREO ■ ANTI LIME
- ANTI-CALCAIRE ■ ANTICALCARE

ANTICALC

■ LÍQUIDO ■ LIQUID ■ LIQUIDE ■ LIQUIDO



Ref. 76049 1 L Pack 12 8 427370 760495



Ref. 76048 5 L Pack 4 8 427370 760488

- Para evitar la formación de cal. Secuestrante de metales (hierro, cobre...)
- To prevent lime formation. Metal Sequestering Agents (iron, copper...)
- Pour éviter la formation de calcaire. Séquestrant de métaux (fer, cuivre, etc.)
- Evita la formazione del calcare. Sequestrante di metalli (ferro, rame)

STOP METAL

■ LÍQUIDO ■ LIQUID ■ LIQUIDE ■ LIQUIDO



Ref. 76114 5 L Pack 4 8 412081 290331

- Especial para aguas duras: perforaciones, pozos, arroyos... Secuestrante de sales metálicas, evita los depósitos calcáreos
- Specially for hard waters: boreholes, wells, streams... Metal salts sequestrant, prevents scale deposits
- Spécialement pour les eaux dures : forages, puits, cours d'eau... Séquestre les sels métalliques, évite les dépôts de calcaire.
- Appositamente studiato per le acque dure: pozzi, pozzetti, ruscelli... Trattiene i sali metallici e previene i depositi di calcare.

1 Start **2 Play** **3 Stop**

■ Le facilitará la puesta en marcha de la piscina después del invierno, evitando la formación de algas y de cal.

Realizar el proceso cuando la temperatura del agua de la piscina sea inferior a 15°C.

- 1) Limpiar la piscina.
- 2) Ajustar el pH entre 7,2 - 7,6
- 3) Realizar una cloración de choque
- 4) Dejar en funcionamiento el filtro hasta el día siguiente
- 5) Realizar una limpieza del filtro
- 6) Añadir el invernador

■ It makes easier for you the start-up of the pool after winter, avoiding algae and lime formation.

Please carry out the following if the temperature of the water drops below 15°C.

- 1) Clean the swimming pool
- 2) Set the pH balance between 7.2 - 7.6
- 3) Carry out a chlorine crash course
- 4) Leave the filter running until the following day
- 5) Clean the filter
- 6) Add the winterizing agent



- INVERNADOR
- WINTERISER
- HIVERNAGE
- TRATTAMENTO PER L'INVERNO

HIVERNAGE

■ LÍQUIDO ■ LIQUID ■ LIQUIDE ■ LIQUIDO



Ref. **76050** 1 L Pack 12 8 427370 760501



Ref. **76051** 5 L Pack 4 8 427370 760518

■ Les produits de traitement de l'eau vous facilitent la remise en route de la piscine après la période d'hivernage, en évitant la formation d'algues et de calcaire. Procéder au traitement lorsque la température de l'eau de la piscine est inférieure à 15°C.

- 1) Nettoyer la piscine
- 2) Ajuster le pH entre 7,2 - 7,6
- 3) Réaliser une chloration de choc
- 4) Laisser fonctionner le filtre jusqu'au lendemain
- 5) Nettoyer le filtre
- 6) Ajouter l'hivernant

■ Renderà più semplice l'inizio della nuova Stagione, dopo l'inverno, evitando la formazione di alghe e calcare.

Realizzare la procedura quando la temperatura dell'acqua della piscina è inferiore a 15°C.

- 1) Pulire la piscina
- 2) Regolare il pH tra 7,2 e 7,6
- 3) Effettuare una clorazione d'urto
- 4) Lasciare in funzione il filtro fino al giorno successivo
- 5) Effettuare una pulizia del filtro
- 6) Aggiungere lo svernante
- 6) Add the winterizing agent



- INVERNADOR CON BOYA MULTIFUNCIÓN
- MULTI-ACTION FLOAT WINTERISER
- BOUÉE HIVERNAGE MULTI-ACTION
- TRATTAMENTO PER L'INVERNO GALLEGGIANTE MULTI-FUNZIONE

HIVER FLOAT

■ PASTILLAS ■ TABLETS ■ PASTILLES ■ PASTIGLIE



Ref. **76080L** 1,75 Kg Pack 8 8 412081 321004

■ producto químico ■ chemicals ■ produits d'entretien ■ prodotti chimici

BEFORE

AFTER

■ GAMA QUÍMICO ECO ■ ECO CHEMICALS
 ■ PRODUITS D'ENTRETIEN ECO ■ PRODOTTI CHIMICI ECO

■ REGULADORES DE PH ■ PH REGULATORS ■ RÉGULATEURS DE PH ■ CORRETTORI DI PH



■ Minorador de pH granulado ■ Granules pH reduce
 ■ pH moins sous forme de granulés ■ Riduttore pH granulato

90001  5 Kg Pack 4 8 427370 900013



■ Minorador de pH líquido ■ Liquid pH reduce ■ pH moins liquide ■ Riduttore pH liquido

90003  5 l Pack 4 8 412081 313931



90008  25 l Pack 1 8 412081 313955

■ Incrementador de pH granulado ■ Granules pH increase ■ pH plus sous forme de granulés ■ Incrementatore pH granulato

90005  4,5 Kg Pack 4 8 427370 900051

■ Incrementador de pH líquido ■ Liquid pH increase ■ pH plus sous forme de liquide ■ Incrementatore pH liquido

90048  1 l Pack 12 8 427370 900488

90006  5 l Pack 4 8 427370 900068



■ HIGIENIZANTES ■ SANITIZINGS ■ HYGIÉNISATION ■ IGIENIZZANTI

■ Cloro lento tabletas 250 gr ■ Slow chlorine 250 gr tablets ■ Chlore lent galets 250 gr
 ■ Cloro Lento pastiglie 250g

90055L  1 Kg Pack 18 8 412081 320748



90010L  5 Kg Pack 4 8 412081 320779

90058L   5 Kg PALETTE 5 Kg Pack 120 8 412081 320823

90012L  10 Kg Pack 2 8 412081 320830

■ Cloro 4 acciones tabletas 250 gr ■ Chlorine 4 actions 250 gr tablets
 ■ Chlore 4 actions galets 250 gr ■ Cloro 4 azioni pastiglie 250g

90052L  1 Kg Pack 18 8 412081 320168



90025L  5 Kg Pack 4 8 412081 320229

90200L   5 Kg BOX 5 Kg BOX 60 8 412081 320298

90057L   5 Kg PALETTE 5 Kg PAL 120 8 412081 320281



90027L  10 Kg Pack 2 8 412081 320335

■ Cloro 5 acciones tabletas 250 gr ■ Chlorine 5 actions 250 gr tablets
 ■ Chlore 5 actions galets 250 gr ■ Cloro 5 azioni pastiglie 250g

90051L  5 Kg Pack 4 8 412081 320373

■ Cloro choque pastillas 30 gr ■ Shock chlorine 30 gr tablets ■ Chlore choc galets 30 gr
 ■ Cloro shock pastiglie 30 g



90078L  1 Kg Pack 18 8 

90073L  5 Kg Pack 4 8 

90084L  8412081320595

90203L   BOX 5 Kg BOX 60 8 

90082L  8412081320854



90072L   PALETTE 5 Kg PAL 120 8 

90074L  10 Kg Pack 2 8 

90083L  8412081320670

■ Cloro choque granulado ■ Granules shock chlorine
 ■ Chlore choc sous forme de granulés ■ Cloro shock granulato



90050  1 Kg Pack 18 8 

90020  5 Kg Pack 4 8 

90081  8412081315355



90060   PALETTE 5 Kg PAL 120 8 

90021  10 Kg Pack 2 8 

90079  8412081315348

■ TRATAMIENTO ANTIALGAS ■ ANTI-ALGAE TREATMENT ■ TRAITMENT ANTI-ALGUES
 ■ TRATTAMENTO ANTIALGHE

■ Antialgas liquido concentrado ■ Liquid anti-algae ■ Anti-algues liquide ■ Antialghe liquido concentrato



90053  1 l Pack 12 8 

90030  5 l Pack 4 8 

90202   BOX 5 l BOX 48 8 

90032  10 l Pack 1 8 

■ FLOCULANTE ■ FLOCCULANT ■ FLOCULANT ■ FLOCCULANTE

■ Floculante liquido ■ Liquid flocculant ■ Flocculant liquide ■ Floculante liquido



90054  1 l Pack 12 8 

90042  5 l Pack 4 8 

■ Floculante cartucho ■ Cartridge flocculant ■ Flocculant cartouche ■ Floculante a cartuccia



90046  1 Kg Pack 14 8 

■ INVERNADOR ■ WINTERISER ■ HIVERNAGE ■ PRODOTTI CHIMICI PER L'INVERNO

■ Invernador liquido ■ Liquid winteriser ■ Hivernage liquide ■ Trattamento per l'inverno liquido



90035  5 l Pack 4 8 

SaniPLUS



76093

- **Higienizante multi-superficies.** 1l en formato spray para superficies pequeñas y un fácil uso.
- **Multi-surface sanitizer.** 1l in spray format for small surfaces and easy use.
- **Désinfectant multi-surfaces.** 1l en format spray pour petites surfaces et utilisation facile.
- **Igienizzante multi-superfici.** 1l formato spray per piccole superfici e di semplice utilizzo.

🇫🇷 Uniquement pour la France et le Portugal
🇵🇹 Only for France and Portugal



DIS Pack 9



90178

- **Repulsivo Anti Insectos** a base de aceites esenciales 100% naturales. Caja de 6 pastillas de 30g.
- **Anti Insect repellent** using 100% natural essential oils. 30g 6 tablet box.
- **Répulsif Anti Insectes** à base d'huiles essentielles 100% naturelles. Boite carton de 6 pastilles de 30g.
- **Repellente anti-insetti** a base di oli essenziali 100% naturali. Confezione di 6 pastiglie da 30g.

🇫🇷 Uniquement pour la France et le Portugal
🇵🇹 Only for France and Portugal



DIS Pack 12



76094

- **Higienizante multi-superficies.** 5l para grandes superficies.
- **Multi-surface sanitizer.** 5l for large surfaces.
- **Désinfectant multi-surfaces.** 5l pour les grandes surfaces.
- **Igienizzante multi-superfici.** 5l per grandi superfici.

🇫🇷 Uniquement pour la France et le Portugal
🇵🇹 Only for France and Portugal



DIS Pack 9



90175

- **Repulsivo Anti Insectos** a base de aceites esenciales 100% naturales. Dosificador de 3 pastillas de 30g.
- **Anti Insect repellent** using 100% natural essential oils. 30 g 3 tablet dosifier.
- **Répulsif Anti Insectes** à base d'huiles essentielles 100% naturelles. Doseur de 3 pastilles de 30g.
- **Repellente anti-insetti** a base di oli essenziali 100% naturali. Dosatore di 3 pastiglie da 30g.

🇫🇷 Uniquement pour la France et le Portugal
🇵🇹 Only for France and Portugal



DIS Pack 9





76077

- **Stop Aguas Verdes.** 5 litros. Doble acción: floculante y algicida
- **Stop Green Waters.** 5 litres. Double action: flocculant and algicide
- **Stop Eaux Vertes.** 5 litres. Double action : floculant et algicide
- **Stop Acque Verdi.** 5 litri. Doppia azione: flocculante e algicida

 Uniquement pour la France et le Portugal

 Solo per Francia, Italia e Portogallo

 Only for France, Italy and Portugal



DIS Pack 12



90143

- **Out Aguas Turbias.** Recupera las aguas turbias, y consigue un agua limpia y cristalina. Caja de 6 pastillas de 30g.
- **Out Cloudy Waters.** Get back the cloudy waters to obtain a cristal-clear water. 30g 6 tablet box.
- **Out Eaux Troubles.** Traite les eaux troubles, et rend l' eau propre et cristalline. Boite carton de 6 pastilles de 30g.
- **Out Acque Torbide.** Recupera le acque torbide, la sua efficacia permette di avere un'acqua limpida e cristallina. Confezione di 6 pastiglie da 30g.



DIS Pack 12



90147

- **Out Aguas Verdes.** Recupera las aguas verdes gracias a una nueva generación de polimeros hidrosolubles. Caja de 6 pastillas de 20g.
- **Out Green Waters.** Get back the green waters of your pool thanks to a new generation of water soluble polymers. 20g 6 tablet box.
- **Out Eaux Vertes.** Il récupère les eaux vertes grâce à une nouvelle génération de polymères hydrosolubles. Boite carton de 6 pastilles de 20g.
- **Out Acque Torbide.** Recupera le acque torbide, la sua efficacia permette di avere un'acqua limpida e cristallina. Confezione di 6 pastiglie da 20g.



DIS Pack 12



SATC6

- **Out Aguas Turbias.** Recupera las aguas turbias, y consigue un agua limpia y cristalina. Para piscinas con filtro de cartucho. Caja de 6 pastillas de 17g.
- **Out Cloudy Waters.** Get back the cloudy waters to obtain a cristal-clear water. For pools with cartridge filter. 17g 6 tablet box.
- **Out Eaux Troubles.** Traite les eaux troubles, et rend l' eau propre et cristalline. Convient pour les piscines avec filtration à cartouche. Boite carton de 6 pastilles de 17g.
- **Out Acque Torbide.** Recupera le acque torbide, la sua efficacia permette di avere un'acqua limpida e cristallina. Per le piscine con filtro a cartuccia. Confezione di 6 pastiglie da 17g.



DIS Pack 12



■ producto químico ■ chemicals ■ produits d'entretien ■ prodotti chimici

■ POOLP'OS ■ POOLP'OS
■ POOLP'OS ■ POOLP'OS



- Cómo utilizar Poolp'o
- How to use Poolp'o
- Comment utiliser Poolp'o
- Come utilizzare Poolp'o

■ Solución de tratamiento "Todo en Uno". Ideal piscinas elevadas con o sin filtración. Tratamiento mensual. 4 Acciones: Higienizante, Antibacterias, Antialgas y Floculante

- No hay manipulación directa de producto químico. No perjudica la filtración gracias a su forma optimizada que deja el circuito de agua intacto. El POOLP'O sube a la superficie una vez acabado el producto químico, avisando de la necesidad de empezar un nuevo tratamiento.

■ Solution de traitement "Tout en Un". Idéal pour les piscines hors-sol avec ou sans filtration. Nécessite un traitement mensuel. 4 Actions: Hygiénisant, Antibactéries, Anti-algues, Flocculant.

- Pas de manipulation directe de produits chimiques. - N'endommage pas le système de filtration grâce à sa forme optimisée qui laisse le circuit de l'eau intact. Ne gêne pas le volet du skimmer de par sa petite taille. Le POOLP'O remonte à la surface une fois que le produit chimique est consommé, prévenant ainsi de la nécessité de commencer un nouveau traitement.

■ Treatment solution "All in One" for Above ground Pools with and without filtration. Monthly treatment. 4 actions: Sanitizing, Anti-bacteria, Anti-algae and Flocculant.

- No direct handling of chemical product. It does not obstruct filtration thanks to its form optimized - which leaves the circuit of water intact. It goes up once product finished, so you know you should start a new treatment.

■ Soluzione "Tutto in uno". Adatto per piscine fuori terra con o senza filtrazione. Trattamento mensile. 4 azioni: Igienizzanti, Anti-batteri, Antialghe e Flocculante

- Non c'è contatto diretto con il prodotto chimico. Non danneggia la filtrazione grazie alla sua forma che lascia libero il circuito dell'acqua. El Poolp'o sale in superficie una volta terminato il prodotto chimico, avisando della necessità di dover iniziare un nuovo trattamento



08012L

- POOLP'O 0-10m³ (250g). Duración 4 semanas.
- POOLP'O 0-10m³ (250g) 4 weeks.
- POOLP'O 0-10m³ (250g). Durée 4 semaines.
- POOLP'O 0-10m³ (250g). 4 settimane.



BX Pack 16



08013AL

- POOLP'O 10-20m³(500g) Duración 4 semanas.
- POOLP'O 10-20m³(500g) 4 weeks.
- POOLP'O 10-20m³(500g). Durée 4 semaines.
- POOLP'O 10-20m³(500g). 4 settimane.



BX Pack 16



08099AL

- POOLP'O 10-30m³ (700g). Duración 3 semanas.
- POOLP'O 10-30m³ (700g). 3 weeks.
- POOLP'O 10-30m³ (700g). Durée 3 semaines.
- POOLP'O 10-30m³ (700g). 3 settimane.



BX Pack 9



■ KITS PISCINA ■ POOL KITS
 ■ KITS POUR PISCINE ■ KIT PER PISCINE



76053

- **Kit para piscina de 0 a 5m³.** Cloro lento pastillas de 5 g - 500 g + Dosificador + Pelota
- **Kit for 0-5m³ pool.** Trichlorine 5g tablets - 500 g + Dispenser + Ball
- **Kit pour piscine de 0 à 5m³.** Chlore lent pastilles de 5 g - 500 g + Doseur + Ballon
- **Kit per piscina da 0 a 5m³.** Cloro lento pastiglie da 5g - 500g + dosatore + palla gonfiabile



Pack 12



76110

- **Fórmula 4 acciones: cloro, algicida, floculante y estabilizador de cloro.** Evita el desarrollo de algas. Para piscinas hasta 20m³. Pastillas de 100 g - 1kg.
- **4-way action formula: chlorine, algacide, flocculant and chlorine stabilizer.** Prevents the development of algae. For pools up to 20m³. 100 g tablets - 1kg.
- **Formule à 4 actions : chlore, algicide, floculant et stabilisateur de chlore.** Empêche le développement des algues. Pour les piscines jusqu'à 20m³. Pastilles de 100 g - 1kg.
- **Formula a 4 vie d'azione: cloro, alghicida, floculante e stabilizzatore di cloro.** Previene lo sviluppo delle alghe. Per piscine fino a 20m³. Pastiglie da 100g - 1kg.



Pack 12



76054L

- **Kit para piscina de 5 a 15m³.** Multifunciones pastillas 20g, 1Kg + Dosificador + Termómetro + Analizador + Manguitos + Kit reparación liner
- **Kit for 5-15m³ pool.** Multiactions 20g tablets, 1Kg + Dispenser + Thermometer + Test kit + Arm-bands + Liner repair kit
- **Kit pour piscine de 5 à 15m³.** Multifonctions pastilles 20 g - 1kg + Doseur + Thermomètre + Trousse d'analyse + Brassards + Kit réparation liner
- **Kit per piscina da 5 a 15m³.** 4 azioni pastiglie da 20g, formato 1 Kg + Dosatore + termometro + Kit analisi + Braccioli + Kit riparazione liner



Pack 6



KKP525 - JUNIOR POOL

- **Kit tratamiento químico** para piscinas pequeñas sin filtración. Apto para piscinas sin filtración hasta 1200 litros. 5 bolsas de 25 ml
- **Disinfection** for small pools without filter. Suitable for pools up to 1200 litres without filtration. 5 x 25 ml
- **Kit traitement chimique** pour petits bassins sans filtration. Apte pour piscines sans filtration jusqu'à 1200 litres. 5 x 25 ml
- **Kit tratamiento** per piscina piccola senza filtrazione. Adatto per piscine senza filtrazione fino a 1200 litri. 5 x 25 ml



BX Pack 18



■ producto químico ■ chemicals ■ produits d'entretien ■ prodotti chimici

- KITS SPA ■ SPA KITS
- KITS POUR SPA ■ KIT PER SPA



778776

- Clean SPA 3 en 1. Pastillas de 20 gr - 1 Kg
- Clean SPA 3 in 1. 20g tablets, 1Kg
- Clean SPA 3 en 1. Pastilles 20g -1 kg
- Clean SPA 3 in 1. Pastiglie da 20g, formato 1 Kg

Referencia no disponible para España



Pack 12



OXYSPA

- **TRATAMIENTO QUÍMICO PARA SPA por oxígeno.**
4 x oxígeno 20 g + 2 x minorador de pH 30 g + 8 x oxígeno activo 25 g + 4 x tiras analíticas para oxígeno-pH
- **SPA CHEMICAL TREATMENT based on Oxygen.**
4 x Oxygen 20 g + 2 x pH minus 30 g + 8 x Oxygen activator 25 g + 4 x Oxygen-pH test strips
- **TRAITEMENT CHIMIQUE POUR SPA par oxygène.**
4 x oxygène 20 g + 2 x réducteur de pH 30 g + 8 x oxygène actif 25 g + 4 x bandes de test pour oxygène-pH
- **TRATTAMENTO CHIMICO SPA a base di Ossigeno.**
4 x ossigeno 20 g + 2 x pH minus 30 g + 8 x attivatore di ossigeno 25 g + 4 x strisce per test reattive all'ossigeno, valore del pH

Référence exclusive pour la France



DIS Pack 12



- **Kit tratamiento para Spa.** Spa desinfectante 30g x4 + pH plus 20g x2 + pH menos 30g x2
- **Kit with chemical treatment for Spa.** Spa disinfect 30g x4 + pH reduce 20g x2 + pH increase 30g x2
- **Kit traitement pour Spa.** Sachets de désinfection 30g x4 + pH plus 20g x2 + pH moins 30g x2
- **Kit tratamiento per Spa.** disinfezione Spa 30g x4 + incrementatore pH 20g x2+ riduttore pH 30g x2

KTSPAET



DIS Pack 12



KTSPA



DIS Pack 12



KTSPAET



DIS Pack 12





■ **SPA DOSING CAP®**

Spa Dosing CAP® es un sistema de desinfección para SPAs hinchables especialmente desarrollado para el mantenimiento y desinfección del agua.

■ **SPA DOSING CAP®**

Spa Dosing CAP® is a disinfection system for inflatable SPAs specially developed for the maintenance and disinfection of the water.

■ **SPA DOSING CAP®**

Spa Dosing CAP® est un système de désinfection pour les SPAs gonflables spécialement développé pour l'entretien et la désinfection de l'eau.

■ **SPA DOSING CAP®**

Spa Dosing CAP® è un sistema di disinfezione per SPA gonfiabili appositamente sviluppato per la manutenzione e la disinfezione dell'acqua.



- Fije el dispensador en la boquilla del spa.
- Fix the dispenser on the spa nozzle.
- Fixez le distributeur sur la buse du spa.
- Fissare l'erogatore sull'ugello della vasca idromassaggio.

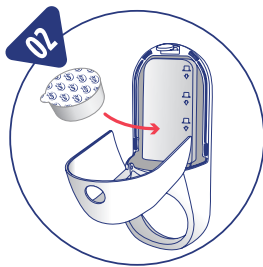

- Introduzca los caps necesarios.
- Insert the necessary caps.
- Insérez les bouchons nécessaires..
- Inserire i caps necessari.

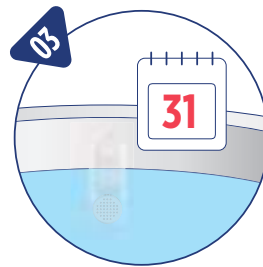

- Disfruta durante 1 mes.
- Enjoy for 1 month.
- Profitez-en pendant 1 mois.
- Godere per 1 mese.

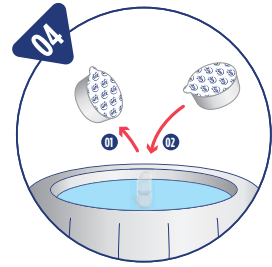

- Vuelva a colocar el tapón sin necesidad de retirar el dispensador del spa.
- Replace the cap without need remove the dispenser from the spa.
- Remettez le bouchon en place sans avoir à retirer le distributeur du spa.
- Riposizionare il tappo senza dover rimuovere l'erogatore dalla vasca idromassaggio.



- Dispensador + 2 caps ■ Dispenser + 2 caps
- Distributeur + 2 caps ■ Dispenser + 2 caps

SCAPEPI20



CBX Pack 9



- Recambio (6 cápsulas) ■ Refill (6 caps)
- Recharge (6 capsules) ■ Ricarica (6 capsule)

SCAPEPI60



CBX Pack 12



SCAPFDA20



CBX Pack 9



SCAPFDA60



CBX Pack 12



■ producto químico ■ chemicals ■ produits d'entretien ■ prodotti chimici

■ ANALIZADORES ■ TEST KITS ■ TROUSSES D'ANALYSE ■ KIT TEST



40062

■ **Comparador cloro + pH - pastillas DPD1.** Determina de manera rápida y precisa el nivel de Cloro y pH en el agua de la piscina

■ **Test kit chlorine + pH - DPD1 tablets.** Quickly and accurately determines the level of chlorine and pH in pool water

■ **Trousse d'analyse de chlore + pH - pastilles DPD1.** Détermine de manière rapide et précise le niveau de chlore et le pH dans l'eau de la piscine.

■ **Kit analisi cloro + ph - pastiglie DPD1.** Stabilisce rapidamente e con precisione il livello di cloro e pH nell'acqua della piscina.



DIS 1/8 CS Pack 24



40063

■ **Recambio pastillas DPD1.** Incluye 20 reactivos para medir el pH y 20 reactivos para medir el cloro.

■ **Refill DPD1 tablets.** Includes 20 indicators to measure pH and 20 DPD4 indicators to measure chlorine

■ **Recharge pastilles DPD1.** Inclut 20 réactifs pour mesurer le pH et 20 réactifs pour mesurer le chlore

■ **Ricarica pastiglie DPD1.** Include 20 reagenti per la misurazione del pH e 20 reagenti per la misurazione del cloro



DIS 1/8 BL Pack 24



40066

■ **Kit de análisis de oxígeno/bromo + pH - pastillas DPD4.** Incluye 20 reactivos de pH y 20 reactivos de DPD4

■ **Oxygen / bromine + pH test kit - DPD4 tablets.** Includes 20 pH indicators and 20 DPD4 indicators.

■ **Trousse d'analyse d'oxygène/brome + pH pastilles DPD4.** Inclut 20 réactifs de pH et 20 réactifs de DPD4

■ **Kit analisi ossigeno/bromo + pH pastiglie DPD4.** Include 20 reagenti per il pH e 20 reagenti per DPD4



DIS 1/8 CS Pack 24



40067

■ **Recambio pastillas DPD4.** Incluye 20 reactivos para medir el pH y 20 reactivos de DPD4 para la medición de Oxígeno

■ **Refill DPD4 tablets.** Includes 20 indicators to measure pH and 20 DPD4 indicators to measure Oxygen

■ **Recharge pastilles DPD4.** Inclut 20 réactifs pour mesurer le pH et 20 réactifs de DPD4 pour mesurer l'oxygène

■ **Ricarica pastiglie DPD4.** Include 20 reagenti per la misurazione del pH e 20 reagenti per DPD4 per la misurazione dell'ossigeno



DIS 1/8 BL Pack 24





- Cómo ajustar el pH de la piscina
- How to adjust pool pH
- Comment ajuster le pH de la piscine
- Come regolare il pH della piscina



40060

- **Analizador** de cloro/bromo + pH (Oto/Phenol). Incluye un estuche para guardar el kit de análisis
- **Test kit** chlorine/bromine + pH (Oto/Phenol). Includes a case to store the analysis kit
- **Trousse d'analyse** de chlore/brome + pH (Oto/Phénol). Inclut un étui pour ranger le kit de tests
- **Kit analisi** cloro/bromo + pH (oto/Phenol). Include un astuccio per conservare il kit di analisi



40061

- **Recambio de Oto/Phenol** para el análisis del Cloro/Bromo y pH de la piscina
- **Refill of Oto/Phenol** for the analysis of Chlorine/Bromide and pool pH
- **Recharge d'Oto/Phénol** pour l'analyse du chlore/brome et du pH de la piscine
- **Sostituzione di Oto/Phenol** per l'analisi di cloro/bromo e pH della piscina



CBX Pack 16



CBX Pack 12



■ TIRAS ANALÍTICAS ■ ANALYSIS STRIPS

■ LANGUETTES D'ANALYSE ■ STRISCE DI ANALISI



40068

- **Tiras de análisis del cloro, pH y alcalinidad** del agua de la piscina. 50 tiras.
- **Chlorine analysis indicators pH and alkalinity** of the water of the pool. 50 strips
- **Bandelettes de tests du chlore du pH et de l'alcalinité** de l'eau de la piscine. 50 languettes
- **Strisce di analisi del cloro pH e alcalinità** dell'acqua della piscina. 50 strisce



40069

- **Tiras de análisis del nivel de sal en la piscina.** Incluye 16 tiras desechables
- **Analysis indicators of the salt level in the pool.** Includes 16 single use indicators
- **Bandelettes de tests du niveau de sel dans la piscine.** Inclut 16 languettes jetables
- **Strisce di analisi del livello di sale nella piscina.** Include 16 strisce usa e getta



1/8 CBX Pack 16



CBX Pack 12



■ Leyenda ■ Legend ■ Légende ■ Legenda

	Medidas	Measures	Mesures	Misure
	Profundidad	Depth	Profondeur	Profondità
	Litros	Litres	Litres	Litri
	Escalera	Ladder	Échelle	Scala
	Tapiz	Tapsetry	Tapis	Telo di protezione
	Espacio necesario	Necessary space	Espace necessaire	Spazio necessario
	Altura	Height	Hauteur	Altezza
	Espesor	Thickness	Épaisseur	Spessore
	Potencia	Power rating	Puissance	Potenza
	Voltios	Volts	Volts	Volt
	Vatios	Watts	Watts	Watts
	Energía solar	Solar energy	Énergie solaire	Energia solare
	Tubo telescópico	Telescopic tube	Tube telescopique	Tubo telescopico
	Manguera	Hose	Tuyau	Tubo
	Cable	Wire	Câble	Cavo
	Tiempo de carga	Recharging time	Temps de charge	Tempo di carica
	Tipo de batería	Battery type	Type de batterie	Tipo di batteria
	Velocidad	Speed	Vitesse	Velocità
	Potencia de succión	Suction power	Puissance d'aspiration	Potenza di aspirazione
	Capacidad de filtrado	Filter capacity	Capacité de filtration	Capacità de filtro
	Tiempo de funcionamiento	Operating time	Temps de fonctionnement	Tempo di operatività
	Diámetro cuba	Tank diameter	Diamètre du cuve	Diametro del cestello.
	Capacidad cuba	Tank capacity	Capacité du cuve	Capacità del cestello.
	Nº de vías	Number of way	Nombre de voies	Numero di uscite
	Caudal	Flow	Débit	Portata
HP	CV	HP	HP	HP
	Volumen máximo	Max. volume	Volume maximal	Volume massimo
	Superficie	Surface	Surface	Superficie
	Filtración	Filtration	Filtre	Filtro
	Tipo de cartucho	Cartridge type	Type de cartouche	Tipo di cartuccia
	Tipo de filtro de cartucho	Cartridge filter type	Type de filtre à cartouche	Tipo di filtro a cartuccia
	Peso	Weight	Poids	Peso
	Granulometría	Grains size	Granulométrie	Granulometria

	Producción de cloro	Chlorine production	Production de cloro	Produzione di cloro
	Lumens	Lumens	Lumens	Lumens
	Vida útil	Long life	Durée de vie	Vita utile
	Grifo lavapies	Footwash tap	Robinet lave pieds	Rubinetto lavapiedi
	Embalaje	Packaging	Emballage	Imballaggio
BX	Caja	Box	Carton	Scatola
BXL	Caja con etiqueta	Box with label	Carton avec étiquette	Scatola con etichetta
CB	Cartoncillo	Cardboard	Bande carton	Cartone
PBH	Bolsa de plástico con cartoncillo	Polybag with header	Sac plastique avec bande carton	Sacchetto di plastica con cartone
BL	Blister	Blister	Blister	Blister
CS	Doble burbuja	Clamshell	Double coque	Doppio rivestimento
CBX	Caja litografiada	Colour box	Boîte de couleur	Scatola serigrafata
PB	Bolsa de plástico	Polybag	Sac plastique	Sacchetto di plastica
DIS	Display	Display	Display	Display
	Código EAN	EAN code	Code EAN	Codice EAN

- Material PLV ■ Pos material
- Matériels PLV ■ Materiale Pos



- EXPOSITOR PISCINA CHAPA ■ STEEL POOL EXHIBITOR
- PRÉSENTOIR PISCINE ACIER ■ EXPOSITORI PISCINE PARETI IN ACCIAIO



- TOTEMS CARTÓN ■ CARDBOARD TOTEMS
- TOTEMS CARTON ■ TOTEMS CARTONE

- FOLLETOS ■ LEAFLETS
- DÉPLIANTS ■ VOLANTINI



- EXPOSITOR ROBOTS
- ROBOTS EXHIBITOR
- PRÉSENTOIR ROBOTS
- EXPOSITORI ROBOTS



- ROLL UP
- ROLL UP
- ROLL UP
- ROLL UP

- Nos reservamos el derecho de cambiar total o parcialmente las características de nuestros artículos o el contenido de este documento sin previo aviso. Fotos e imágenes no contractuales.
- We reserve the right to change all or part of the articles or contents of this document without prior notice. Photos and pictures are not contractual.
- Nous nous réservons le droit de modifier totalement ou en partie les caractéristiques de nos articles ou le contenu de ce document sans préavis. Photos et images non contractuelles.
- Ci riserviamo il diritto di cambiare totalmente o parzialmente le caratteristiche tecniche dei nostri prodotti ed il contenuto di questo documento senza nessun preavviso. La Fotografia o il disegno è solo a scopo illustrativo ed informativo.

■ **Sede social** ■ **Headquarters** ■ **Siège social** ■ **Sede centrale**
Manufacturas GRE S.A. | Aritz Bidea nº 57 | Belako Industrialdea |
Apartado 69 | 48100 Mungia (Bizkaia) Spain
Tel. (34) 946 741 116 | Fax (34) 946 741 708 | gre@gre.es

Bureau Commercial France
Av. Alcalde Barnils, nº 69, 08174 Sant Cugat del Vallès, Barcelona
Tel : 09 73 32 57 01 | Fax : 09 73 32 57 00 | gre@grefrance.fr

■ **Servicio Postventa**
<https://www.grepool.com/post-venta>
■ **After-sales service**
www.grepool.com/en/after-sales
■ **Service après-vente**
<https://www.grepool.com/fr/apres-vente>
■ **Servizio post-vendita**
www.grepool.com/it/post-vendita

www.grepool.com



Manufacturas GRE S.A. | Aritz Bidea nº 57 | Belako Industrialdea | Apartado 69 | 48100 Mungia (Bizkaia) Spain
Tel. (34) 946 741 116 | Fax (34) 946 741 708 | gre@gre.es

A Fluidra Brand | Grepool.com

©2023 Fluidra. All rights reserved. All trademarks and trade names used herein are the property of their respective owners.